

C R E S T W O O D

Simplicity
Face Frame

CATALOG

Crestwood, Inc.
601 E. Water Well Rd. Salina, Kansas 67401
800.235.2618 785.827.0317
www.crestwood-inc.com

CRESTWOOD, INC.

COMPANY DIRECTORY

*Manufacturer of Fine Custom
Cabinetry since 1969*

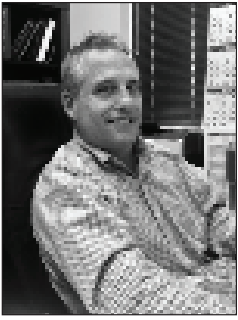

Mike Junk - President
mikej@crestwood-inc.com
785-827-0317 Ext. 112
Cell: 785-826-5993

Sales



Tyler Bogart - Sales/2020
tylerb@crestwood-inc.com
785-827-0317 Ext. 102
Cell: 785-826-7584

Accounting

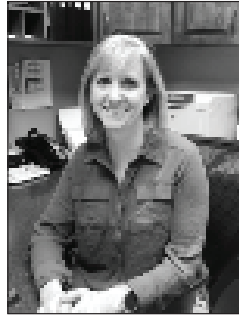

Tammy O'Brien
tammyb@crestwood-inc.com
785-827-0317 Ext. 116



Trena Ekberg
trenae@crestwood-inc.com
785-827-0317 Ext. 114

Shipping/
Customer Service

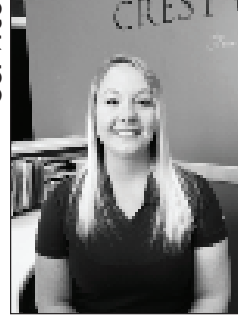

Sabrina Ramirez
sabrinah@crestwood-inc.com
785-827-0317 Ext. 100

Quality Control



Rick Leiker
rickl@crestwood-inc.com
785-827-0317 Ext. 199

Customer Service



Duane Demel
duaned@crestwood-inc.com
785-827-0317 Ext. 181



Delton Blecha
deltonb@crestwood-inc.com
785-827-0317 Ext. 117



Marla Stucky
marlas@crestwood-inc.com
785-827-0317 Ext. 118



Morgan Dobrinski
morgand@crestwood-inc.com
785-827-0317 Ext. 160

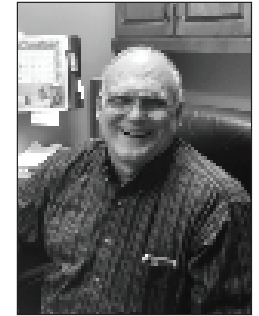

Rod Reel
rodr@crestwood-inc.com
785-827-0317 Ext. 109

IT

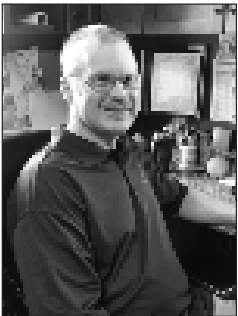

Greg Holeman
gregh@crestwood-inc.com
785-827-0317 Ext. 120

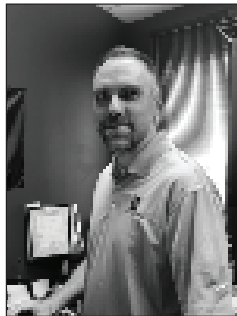

Tyson Swank
tysons@crestwood-inc.com
785-827-0317 Ext. 121



Joe Bernhardt - IT/CPOPS
joeb@crestwood-inc.com
785-827-0317 Ext. 119

Plant Managers



Tom Drane
tomd@crestwood-inc.com
785-827-0317 Ext. 136

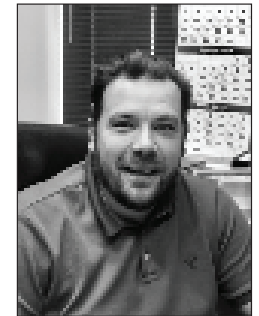

Jerome Schneider
jeromes@crestwood-inc.com
785-827-0317 Ext. 270

Founded in 1969, Crestwood is a second-generation family business. The company began as a small cabinet shop serving the local market and today is a fully integrated manufacturer. Crestwood currently consists of a 300,000 square foot state of the art production facility, which accommodates almost 200 skilled employees, creating one of the country's most modern woodworking facilities. Crestwood continues to grow, not only in size and production, but also with new products to improve our services to you.

601 E. Water Well Rd. Salina, KS 67401
www.crestwood-inc.com





Simplicity
Specifications

Door Index

Simplicity
Face Frame

Specifications

Andover	FR-S17
Aspen	FR-S16
Athena	FR-S17
Belleville	FR-S18
Belmont 1	FR-S22
Belmont	FR-S10
Bennington	FR-S18
Benton	FR-S10
Berkley	FR-S18
Breckenridge	FR-S19
Burlington	FR-S10
Camila	FR-S11
Canton	FR-S11
Carmel	FR-S11
Cassidy	FR-S12
Cedar Crest	FR-S19
Chatham	FR-S12
Colonial	FR-S19
Cranbrooke	FR-S12
Cranbrooke	FR-S23
Crawford	FR-S20
Crosby	FR-S13
Dakota	FR-S13
Fairfield	FR-S13
Fairfield	FR-S23
Freemont	FR-S17
Glendale	FR-S14
Grayson	FR-S14
Heartland	FR-S14
Heartland-MDF	FR-S23
Highland	FR-S20
Jamestown	FR-S20
Layton	FR-S15
Layton-MDF	FR-S24
Lindsey	FR-S21
Mayfield	FR-S21
Prescott	FR-S21
Serenity	FR-S15
Villa	FR-S14
Wakefield	FR-S22

FACE FRAME CABINET SPECIFICATIONS

FACE FRAMES are select solid wood. Stiles and rails are 3/4" x 1-1/2" or 3", kiln-dried to meet rigid standards for strength and non-checking qualities. All face frames are double doweled, pocket screwed and glued at all joints while being held in an automatic framing machine to assure squareness. Face frame stiles have a 3/32" trimmable scribe.

END PANELS are 1/2" engineered board or plywood on unfinished ends and 3/4" engineered board or plywood on finished ends; dadoed to receive tops, bottoms, backs and face frames.

TOP AND BOTTOM PANELS of wall cabinets and bottom panels of base cabinets are 1/2" engineered board or plywood. Cabinet bottoms are reinforced with a center blocking on base cabinets over 30" wide.

BACKS are 1/2" engineered board or plywood.

WOOD STRETCHER BOARDS of 1/2" engineered board, are used for bracing all base cabinets. Stretcher Boards are also used for securing countertops to cabinets.

TOE KICK STRIPS are 1/2" engineered board with wood veneer; finished to match the cabinet exterior, for placement after cabinet installation.

SHELVES are 3/4" engineered board or plywood. Adjustable shelves have steel pin shelf supports equipped with locking system for total safety on 32mm centers. Shelves are not warranted if locking system has not been implemented.

DRAWERS are constructed of 5/8" solid wood sides, backs, and fronts with dovetail corners; and are slotted to receive 1/4" plywood bottoms. Drawer slides are a full extension "TANDEM" slide by BLUM with "BLU-MOTION" Closure Control and feature a 100 pound static load capacity. Drawer fronts are attached using a threaded brass insert, drilled to exact specifications, in the drawer front and attached to the drawer box with a machine screw. This innovative method has much more holding power than standard methods of attaching drawer fronts and also allows the drawer front to be easily adjusted (before hardware installation).

DOORS are constructed of the following materials: Flat doors are 3/4" solid wood. Panel doors are 3/4" solid wood frames with 1/2" solid wood flat insert or 3/4" solid wood raised insert. Maximum suggested door size is 24" x 60", doors over 24" wide or 60" high will not be warranted against warpage.

WOODS are available in ten species: alder, beech, cherry, hickory, knotty alder, maple, quartered sapele, oak, quarter sawn white oak, and walnut. Rustic wood is also available in beech and hickory. Moisture movement in wood is natural. Excessive moisture movement can cause panels to warp, contract, or expand. When wood is installed in an environment with a relative humidity range between 25% and 55% and a temperature range between 65°F and 75°F, it should be in reasonable balance with its surroundings and should remain reasonably stable.

WOOD FINISHES are available in natural or a selection of standard stain colors. The stain is sealed with a penetrating sealer, hand-sanded, and finished with a two-part polyurethane or catalyzed varnish. Finishes are also available in a selection of standard opaque colors. Opaque colors are obtained by applying a two-part polyurethane primer and one coat of pigmented two-part polyurethane. The polyurethane finish is highly resistant to household chemicals, water, alcohol, and mild acids.

CRESTWOOD reserves the right to change the design, construction, or materials listed herein. These changes will always be made to improve the product, or they will be made if certain specified materials become unavailable for reasons beyond our control.

Specifications

Specifications

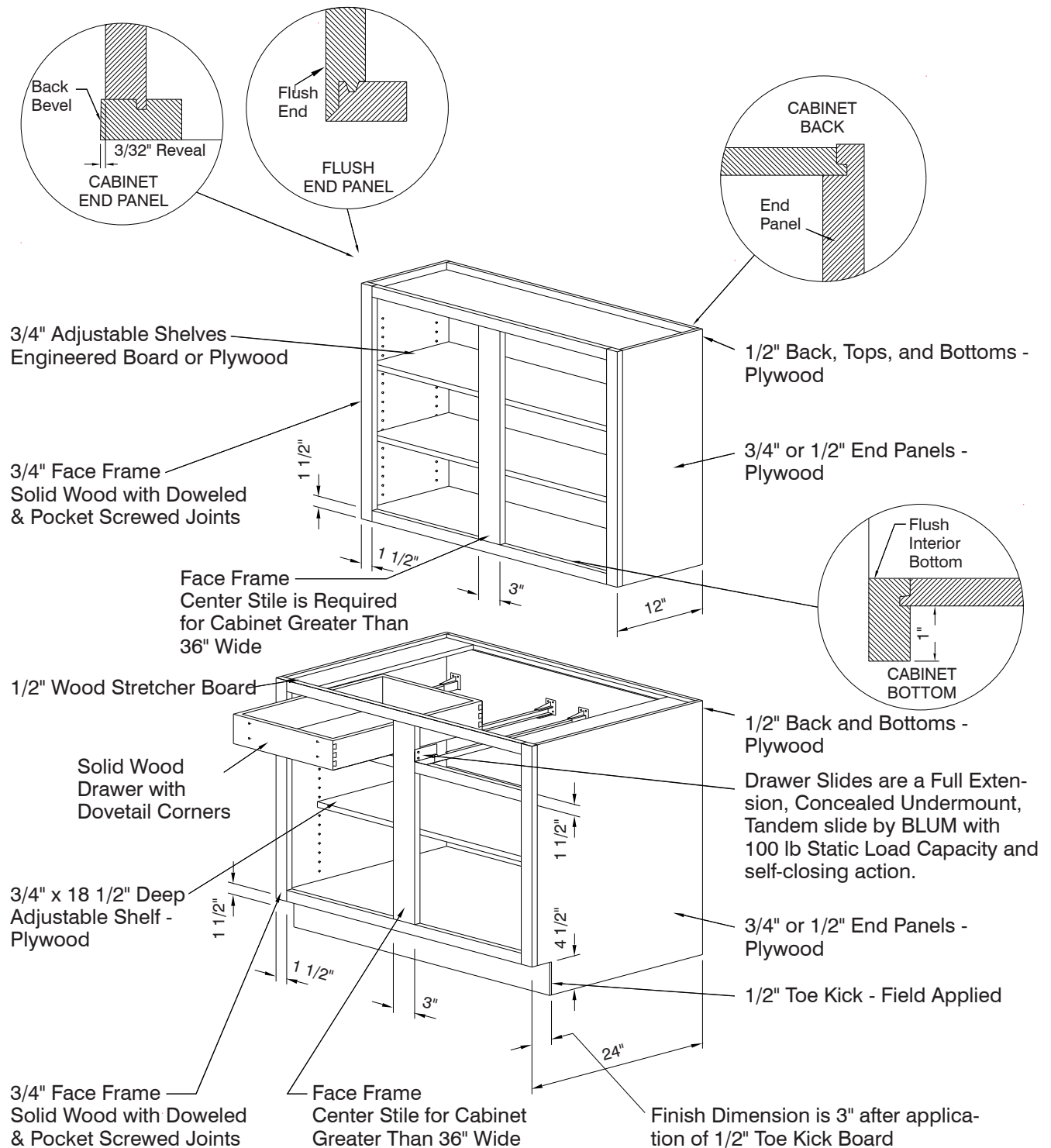

STANDARD SPECIFICATIONS FOR FACEFRAME WALL AND BASE CABINET

NO ADDED UREA FORMALDEHYDE (NAUF)

Formaldehyde is a simple molecule of carbon, hydrogen, and oxygen that comes from both natural and industrial sources; it is formed as other chemicals degrade. Formaldehyde does not accumulate but quickly breaks down to carbon dioxide, hydrogen, and water. Formaldehyde is a natural component of human metabolic processes. The status of formaldehyde as a human health hazard is a major debate in recent years as scientists cannot reach consensus about the available scientific data. Some assert that formaldehyde is a human carcinogen, while others argue that a person is not at risk for cancer at the levels of everyday exposure to formaldehyde emitted in minuscule amounts from consumer and household products.



A breath of fresh thinking comes in the form of PureBond manufactured by Columbia Forest Products. PureBond panel is an innovation that replaces traditional urea-formaldehyde hardwood plywood construction with a new, environmentally safe soy based adhesive. This eliminates urea-formaldehyde adhesive from plywood panels. Crestwood, Inc. is a member of the PureBond Fabricator network. Contact Crestwood, Inc. to see how you can benefit by becoming a member.

Specify NAUF under Cabinet Modifications for No Added Urea Formaldehyde cabinetry.

Crestwood, Inc. assumes no responsibility for product sensitivities. Please consult your health care provider regarding any potential adverse reactions to product being ordered.

LEED® Leadership in Energy and Environmental Design

Using Crestwood, Inc. cabinetry can help you qualify for the following LEED® points:

EQ 4.1	Low Emitting Materials, Adhesives and Sealants	1 Point
EQ 4.2	Low Emitting Materials, Paints and Coatings	1 Point
EQ 4.4	Low Emitting Materials, Composite Wood and Agrifiber Products	1 Point
MR 4.1	Recycled Content, 10%	1 Point
MR 4.2	Recycled Content, 20%	1 Point
MR 5.1	Regional Materials, 20% Manufactured Regionally	1 Point
MR 5.2	Regional Materials, 50% Extracted Regionally	1 Point
MR 6.0	Rapidly Renewable Materials (Bamboo)	1 Point

FINISH

Crestwood uses a high solids two-part polyurethane or high solids water clear conversion varnish. This produces extremely durable films with exceptional depth of image. This product meets or exceeds the performance requirements that have been established by the KCMA (Kitchen Cabinet Manufacturers Association), ASTM (American Society for Testing and Materials) and AWI (Architectural Woodwork Institute). This product has been formulated with very low levels of HAPs (Hazardous Air Pollutants) and VOCs (Volatile Organic Compounds), and is therefore both user and environmentally friendly.

Construction Options

CABINET CONSTRUCTION OPTIONS:

Maple Plywood Interior WMINT: (10%)

1/2", 5-Ply, Purebond™ Plywood Top, Bottom & Back
3/4", 7-Ply, Purebond™ Plywood Finished End Panels
1/2", 5-Ply, Purebond™ Plywood Unfinished End Panels
Plywood Shelves

Maple Melamine Interior MMINT(1/2): (NC)

1/2", Maple Melamine Top, Bottom & Back
3/4", Maple Melamine Finished End Panels
1/2", Maple Melamine Unfinished End Panels
Melamine Shelves

Walnut Plywood Interior WWINT: (10%)

1/2", 5-Ply, Purebond™ Plywood Top, Bottom & Back
3/4", 7-Ply, Purebond™ Plywood Finished End Panels
1/2", 5-Ply, Purebond™ Plywood Unfinished End Panels
Plywood Shelves

*Only available on Painted or Walnut Sets

DRAWER BOX CONSTRUCTION OPTIONS:

Solid Wood Drawer (DWRSW): (NC)

5/8" Solid Wood Sides, Front & Back
Slotted to Receive 1/4" Plywood Bottom
Dovetail Corners

Walnut Drawer (DWRWAL): (10%)

5/8" Solid Walnut Sides
5/8" Solid Walnut Front & Back
Slotted to Receive 1/4" Walnut Plywood Bottom
Finished Dovetail Corners

DOOR HINGING:

Concealed Signature Overlay (NC)

Available on all door styles. Door overlays cabinet frame 1 5/16" at sides and 1" at top of cabinet, 1/4" overlay down (between drawer front/door) and 1 1/4" overlay at bottom of cabinet. Maximum door swing is 110° with soft close feature.

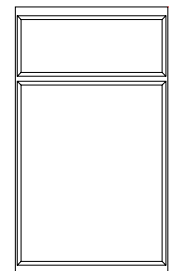

CSOSC

Inset Door with Square Face Frame(INS) (5% UC) or Beaded Face Frame(INB) (8% UC)

Available on select door styles. Specify for Concealed Inset Hinge with Soft Close.

Also available with Faux Decorative Hinge in five finishes:

Square Face Frame (8%) Beaded Face Frame (11%)

- Polished Brass (DPB)
- Polished Nickel (DPN)
- Oil Rubbed Bronze (DOB)
- Satin Nickel (DSN)
- Pewter (DPE)

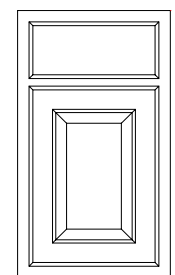
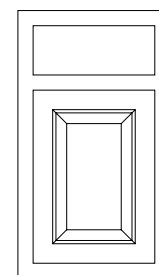

INS-CIHSC (5%) INB-CIHSC (8%)

DOOR AND DRAWER FRONT EDGE PROFILE OPTIONS:

(Optional edge profiles are available on select door styles.)

OVERLAY DOOR EDGE OPTIONS

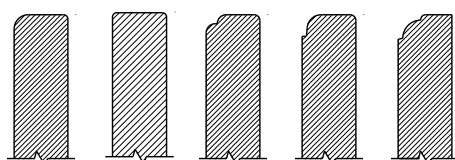

E5 E6 E13 E16 E34

RECOMMENDED INSET DOOR EDGE OPTIONS

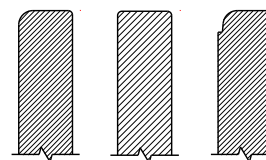

E5 E6 E16

All edge profiles are available in an inset frame application, however, please be aware of how the finished edge sits in relation to the face frame.

CENTER RAIL IN DOOR: (\$217.39)

Two inserts are available on a one insert panel door. Specify center rail location. Locate by giving the dimension from top or bottom edge of door to center line of the center rail. Panel door greater than or equal to 44" in height has two insert panels. Center rail can be relocated. Center rail is not available on all doors, check door description for center rail availability.

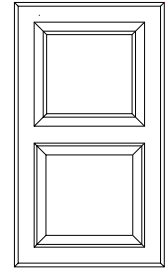

CR

NO CENTER RAIL IN DOOR: (NC)

Panel door greater than or equal to 44" in height has two insert panels. One insert panel is available by indicating no center rail. Panel door with mitered frame has only one insert and no center rail.

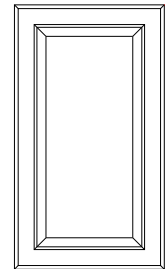

NCR

Door Modifications

PREP DOOR FOR GLASS: (NC)

Doors are prep by notching the back of the frame. Notch is 1/2" wide on wood and laminate doors, for notch width on thermofoil doors, see individual door specifications.

Glass size (depends on width of frame):
 Door (W or H) - Frame (W x 2)
 + 3/4" = Glass (W or H).

Doors greater than 44" in height have a center rail unless specified NCR. Glass is not furnished. Prep doors are not warranted against warpage. Twin ball catch will be sent loose for field installation as needed to help prevent warpage.

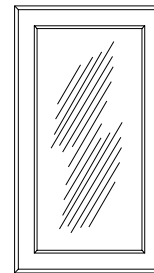

PREP

MULLION INSERT: (40%)

Available on wood panel doors. Door is prep for glass. Door size will dictate the number of lites on door. Center rail on tall door is deleted when specifying MULL. Glass is not furnished. Prep doors are not warranted against warpage.

Prep Mold can be ordered separately for framing in the glass on MULL doors.

MULLION PATTERNS

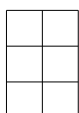

Mull-A

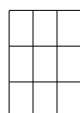

Mull-B

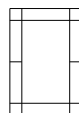

Mull-C

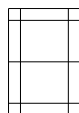

Mull-D

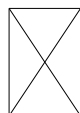

Mull-X*

* NOTE: Mullion Style "X" will always have a flat style mullion due to mullion pattern.

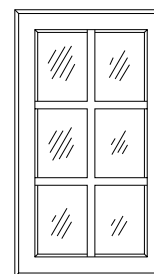

MULL

ALUMINUM DOOR: (100%)

Doors may be modified on an individual cabinet to be Aluminum.



ALUM DR-DIMARO

Door Specifications:
 Maximum width & height, 96"
 Minimum width & height, 6.25"
 Maximum square footage, 32

Insert Specifications:
 6mm (.236") thick
 Can fit 4mm (.156") thick insert with special gasket.



ALUM DR-PRIMA

Door Specifications:
 Maximum width & height, 96"
 Minimum width & height, 5.5"
 Maximum square footage, 24

Insert Specifications:
 4mm (.156") thick
 Handle hole locations must be specified at time of order.



Profile Finishes Options:

— Anodized Aluminum —



natural aluminum



brushed stainless

Glass Insert Options:



satin



clear

PANEL DRAWER FRONT: (3%)

Drawer fronts will be five piece panel drawer fronts.

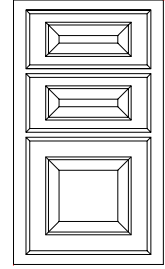

PDF

PANEL DRAWER FRONT LARGE: (3%)

Drawer front greater than 8 3/4" high will be a five piece panel drawer front. This applies to most PDF's. Drawer front with larger rails requires greater height drawer front to be five piece panel drawer front.

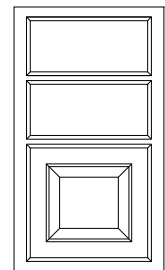

PDFL

PANEL DRAWER FRONT WITH FLAT INSERT: (3%)

Small panel drawer front is available with a flat panel. Drawer front greater than 5 27/32" high will remain a raised panel insert. Drawer front less than 5 1/2" high will remain one piece solid wood.

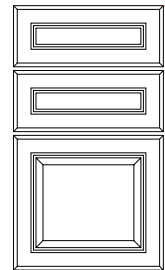

PDFF

Door Styles

Door Styles

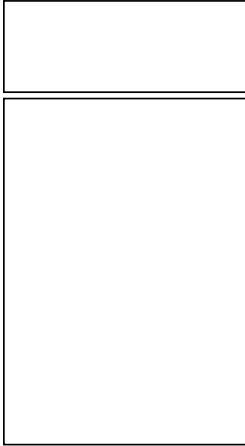

BELMONT (NC)

Drawer Front:
One piece, 3/4" thick, solid wood.

Door:
One piece, 3/4" thick, solid wood.

Size Limits:
Maximum is 24" wide by 60" high.

Remarks:
A one piece, solid wood door needs to be in an environmentally controlled area in order to maintain the stability in expansion and contraction. Not available as Inset door.

Available Modifications:
PREP - Prep Door for Glass (NC)
MULL - Mullion Door (40%)

Available Edge Profiles:

- E5 E6 E13 E16 E34

Mullion Style:

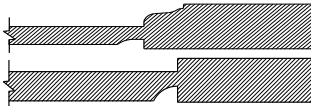
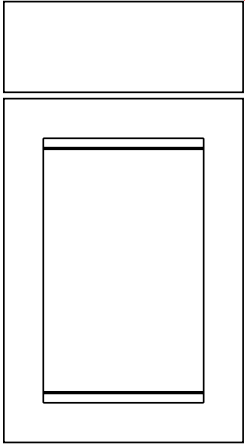
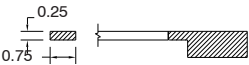

BENTON (NC)

Drawer Front:
One piece, 3/4" thick, solid wood.

Door:
Solid wood frame, 3/4" x 2 1/4" wide stiles and 3/4" x 2 3/4" wide rails. 1/2" solid wood insert.

Size Limits:
Door less than 6 1/2" wide will be one piece.
Maximum is 24" wide by 60" high.

PDF Size Limits:
Drawer fronts smaller than 5" in height will be one piece.
Drawer Front smaller than 8 1/4" in height will have 1 1/2" Rails.

Remarks:
Door is not available with two inserts.

Available Modifications:
PREP - Prep Door for Glass (NC)
MULL - Mullion Door (40%)
PDF - Panel Drawer Front (3%)
PDFL - Panel Drawer Front, Large Only (3%)

Available Edge Profiles:

- E5 E6 E13 E16 E34

Mullion Style:

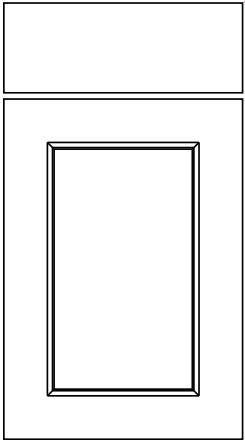
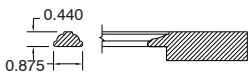

BURLINGTON (5%)

Drawer Front:
One piece, 3/4" thick, solid wood.

Door:
Solid wood frame 3/4" x 3 1/2" wide. 1/2" solid wood insert. French miter construction.

Size Limits:
Door less than 8 1/2" wide will be one piece.
Maximum is 24" wide by 60" high.

PDF Size Limits:
Drawer fronts smaller than 4 1/2" in height will be one piece.
Drawer Front smaller than 8 3/4" in height will have 1 1/2" Rails.

Remarks:
Door is not available with two inserts.

Available Modifications:
PREP - Prep Door for Glass (NC)
PDF - Panel Drawer Front (3%)
PDFL - Panel Drawer Front, Large Only (3%)

Available Edge Profiles:

- E5 E6 E13 E16 E34

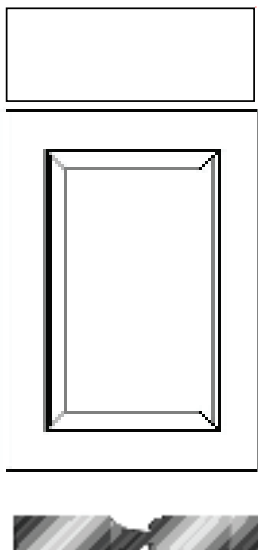

CAMILA (NC)

Drawer Front:

One piece, 3/4" thick, solid wood.

Door:

Solid wood frame 3/4" x 2 1/2" wide. 3/4" solid wood insert.

Size Limits:

Door less than 6 1/2" wide or high will be one piece.

Doors 7 3/4" wide or high and smaller will have a flat insert.

Door greater than or equal to 44" high will have two inserts.

Maximum is 24" wide by 60" high.

Remarks:

Door is not available with two inserts.

PDF Size Limits:

Drawer fronts smaller than 4 1/4" in height will be one piece.

Drawer Front smaller than 8 3/4" in height will have 1 3/8" Rails.

Drawer Front 5 1/2" and smaller than in height will have a flat insert.

Available Modifications:

PREP - Prep Door for Glass (NC)

PDF - Panel Drawer Front (3%)

PDFL - Panel Drawer Front, Large Only (3%)

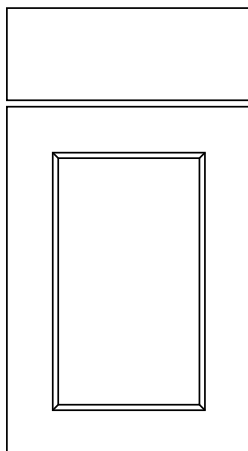

CANTON (NC)

Drawer Front:

One piece, 3/4" thick, solid wood.

Door:

Solid wood frame, 3/4" x 3" wide. 1/2" solid wood insert.

Size Limits:

Door less than 7 1/2" wide will be one piece. Door greater than or equal to 44" high will have two inserts.

Maximum size is 24" wide by 60" high.

PDF Size Limits:

Drawer fronts smaller than 4 1/2" in height will be one piece.

Drawer Front smaller than 8 3/4" in height will have 1 1/2" Rails.

Available Modifications:

PREP - Prep Door for Glass (NC)

MULL - Mullion Door (40%)

NCR - No Center Rail in Door (NC)

CR - Add Center Rail in Door (\$217.39)

PDF - Panel Drawer Front (3%)

PDFL - Panel Drawer Front, Large Only (3%)

Available Edge Profiles:

E5	E6	E13	E16	E34
----	----	-----	-----	-----

Mullion Style:

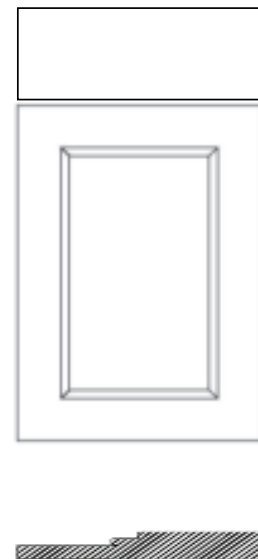
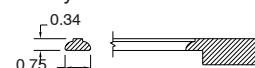

CARMEL (5% up charge)

Drawer Front:

One piece, 3/4" thick, solid wood.

Door:

Solid wood frame, 3/4" x 3" wide. 3/8 Solid Wood Insert. Frame has accent groove at joints. 1/2" solid wood insert.

Size Limits:

Door less than 7 1/2" wide will be one piece. Door greater than or equal to 44" high will have two inserts.

Maximum is 24" wide by 60" high.

PDF Size Limits:

Drawer fronts smaller than 5 1/8" in height will be one piece.

Drawer Front smaller than 9 3/4" in height will have 1 9/16" Rails.

Available Modifications:

PREP - Prep Door for Glass (NC)

MULL - Mullion Door (40% up charge)

NCR - No Center Rail in Door (NC)

CR - Add Center Rail in Door (\$217.39)

PDF - Panel Drawer Front (3% up charge)

PDFL - Panel Drawer Front, Large Only (3% up charge)

Door Styles

Door Styles

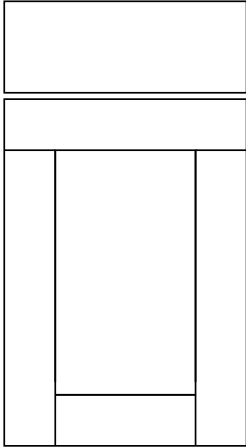

CASSIDY (NC)

Drawer Front:
One piece, 3/4" thick, solid wood.

Door:
Solid wood frame, 3/4" x 3" wide. Frame has accent groove at joints. 1/2" solid wood insert.

Size Limits:
Door less than 7 1/2" wide will be one piece. Door greater than or equal to 44" high will have two inserts. Maximum is 24" wide by 60" high.

PDF Size Limits:
Drawer fronts smaller than 4 1/2" in height will be one piece. Drawer Front smaller than 8 3/4" in height will have 1 1/2" Rails.

- Available Modifications:**
- PREP - Prep Door for Glass (NC)
 - MULL - Mullion Door (40%)
 - NCR - No Center Rail in Door (NC)
 - CR - Add Center Rail in Door (\$217.39)
 - PDF - Panel Drawer Front (3%)
 - PDFL - Panel Drawer Front, Large Only (3%)

Available Edge Profiles:

- E5 E6 E13 E16

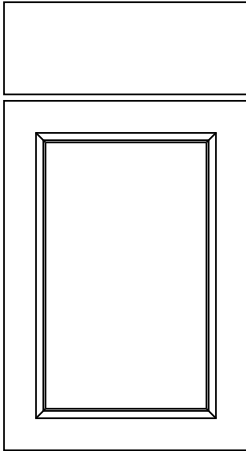

CHATHAM (5%)

Drawer Front:
One piece, 3/4" thick, solid wood.

Door:
Solid wood frame, 3/4" x 2 3/4" wide. 1/2" solid wood insert. French miter construction.

Size Limits:
Door less than 7" wide will be one piece. Door greater than or equal to 44" high will have two inserts and 3.3098" wide center rail. Maximum size is 24" wide by 60" high.

PDF Size Limits:
Drawer fronts smaller than 4 1/2" in height will be one piece. Drawer Front smaller than 8 1/4" in height will have 1 1/2" Rails.

- Available Modifications:**
- PREP - Prep Door for Glass (NC)
 - MULL - Mullion Door (40%)
 - NCR - No Center Rail in Door (NC)
 - CR - Add Center Rail in Door (\$217.39)
 - PDF - Panel Drawer Front (3%)
 - PDFL - Panel Drawer Front, Large Only (3%)

Available Edge Profiles:

- E5 E6 E13 E16 E34

Mullion Style:

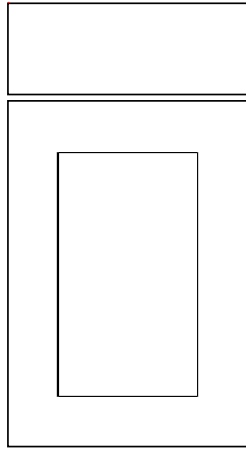
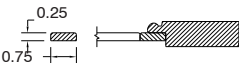

CRANBROOKE (NC)

Drawer Front:
One piece, 3/4" thick, solid wood.

Door:
Solid wood frame, 3/4" x 3" wide. 1/2" solid wood insert.

Size Limits:
Door less than 7 1/2" wide will be one piece. Door greater than or equal to 44" high will have two inserts. Maximum is 24" wide by 60" high.

PDF Size Limits:
Drawer fronts smaller than 4 1/2" in height will be one piece. Drawer Front smaller than 8 3/4" in height will have 1 1/2" Rails.

- Available Modifications:**
- PREP - Prep Door for Glass (NC)
 - MULL - Mullion Door (40%)
 - NCR - No Center Rail in Door (NC)
 - CR - Add Center Rail in Door (\$217.39)
 - PDF - Panel Drawer Front (3%)
 - PDFL - Panel Drawer Front, Large Only (3%)

Available Edge Profiles:

- E5 E6 E13 E16 E34

Mullion Style:

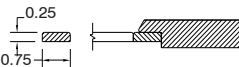

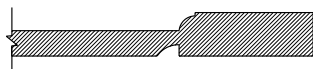
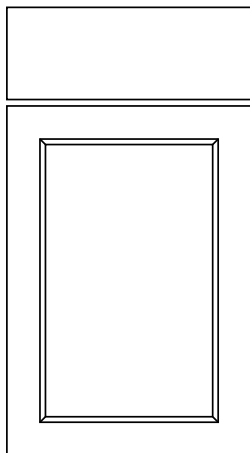

CROSBY (NC)

Drawer Front:

One piece, 3/4" thick, solid wood.

Door:

Solid wood frame, 3/4" x 2 1/4" wide. 1/2" solid wood insert.

Size Limits:

Door less than 6" wide will be one piece. Door greater than or equal to 44" high will have two inserts. Maximum size is 24" wide by 60" high.

PDF Size Limits:

Drawer fronts smaller than 4 1/2" in height will be one piece.
Drawer Front smaller than 7 1/4" in height will have 1 1/2" Rails.

Available Modifications:

- PREP - Prep Door for Glass (NC)
- MULL - Mullion Door (40%)
- NCR - No Center Rail in Door (NC)
- CR - Add Center Rail in Door (\$217.39)
- PDF - Panel Drawer Front (3%)
- PDFL - Panel Drawer Front, Large Only (3%)

Available Edge Profiles:

E5 E6 E13 E16 E34

Mullion Style:

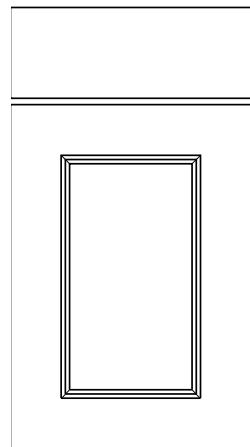
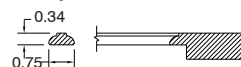

DAKOTA (5%)

Drawer Front:

One piece, 3/4" thick, solid wood.

Door:

Solid wood frame 3/4" x 3" wide. 1/2" solid wood insert. French miter construction.

Size Limits:

Door less than 7 1/2" wide will be one piece.
Maximum size is 24" wide by 60" high.

PDF Size Limits:

Drawer fronts smaller than 5 1/2" in height will be one piece.
Drawer Front smaller than 8 3/4" in height will have 1 1/2" Rails.

Remarks:

Door is not available with two inserts.

Available Modifications:

- PREP - Prep Door for Glass (NC)
- MULL - Mullion Door (40%)
- PDFL - Panel Drawer Front, Large Only (3%)

Available Edge Profiles:

E5 E6 E13 E16 E34

Mullion Style:

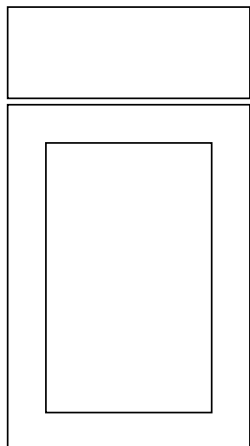
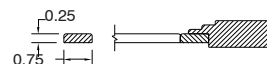

FAIRFIELD (NC)

Drawer Front:

One piece, 3/4" thick, solid wood.

Door:

Solid wood frame, 3/4" x 2 1/4" wide. 1/2" solid wood insert.

Size Limits:

Door less than 6" wide will be one piece. Door greater than or equal to 44" high will have two inserts. Maximum size is 24" wide by 60" high.

PDF Size Limits:

Drawer fronts smaller than 4 1/2" in height will be one piece.
Drawer Front smaller than 7 1/4" in height will have 1 1/2" Rails.

Available Modifications:

- PREP - Prep Door for Glass (NC)
- MULL - Mullion Door (40%)
- NCR - No Center Rail in Door (NC)
- CR - Add Center Rail in Door (\$217.39)
- PDF - Panel Drawer Front (3%)
- PDFL - Panel Drawer Front, Large Only (3%)

Available Edge Profiles:

E5 E6 E13 E16 E34

Mullion Style:

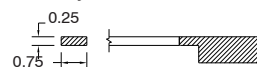

Door Styles

Door Styles

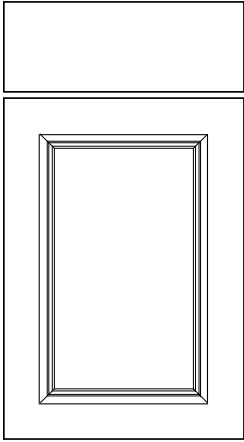

GLENDALE (5%)

Drawer Front:

One piece, 3/4" thick, solid wood.

Door:

Solid wood frame 3/4" x 3" wide. 1/2" solid wood insert. French miter construction.

Size Limits:

Door less than 8" wide will be one piece.

Door greater than or equal to 44" high will have two inserts and 3 3/4" wide center rail.

Maximum size is 24" wide by 60" high.

PDF Size Limits:

Drawer fronts smaller than 5 11/16" in height will be one piece.

Drawer Front smaller than 8 3/4" in height will have 1 11/16" Rails.

Available Modifications:

PREP - Prep Door for Glass (NC)

MULL - Mullion Door (40%)

CR - Add Center Rail in Door (\$217.39)

PDF - Panel Drawer Front (3%)

PDFL - Panel Drawer Front, Large Only (3%)

Available Edge Profiles:

E5 E6 E13 E16 E34

Mullion Style:

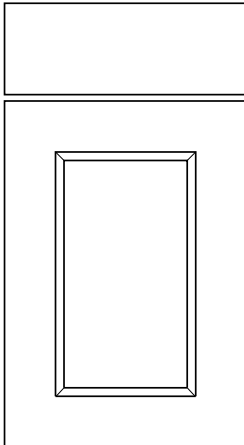
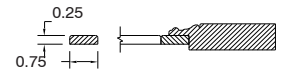

GRAYSON (5%)

Drawer Front:

One piece, 3/4" thick, solid wood.

Door:

Solid wood frame, 3/4" x 3" wide stiles and rails. 1/2" solid wood insert. French miter construction.

Size Limits:

Door less than 7 1/2" wide will be one piece. Door greater than or equal to 44" high will have two inserts.

Maximum is 24" wide by 60" high.

PDF Size Limits:

Drawer fronts smaller than 4 1/2" in height will be one piece.

Drawer Front smaller than 8 3/4" in height will have 1 1/2" Rails.

Available Modifications:

PREP - Prep Door for Glass (NC)

MULL - Mullion Door (40%)

NCR - No Center Rail in Door (NC)

CR - Add Center Rail in Door (\$217.39)

PDF - Panel Drawer Front (3%)

PDFL - Panel Drawer Front, Large Only (3%)

Available Edge Profiles:

E5 E6 E13 E16 E34

Mullion Style:

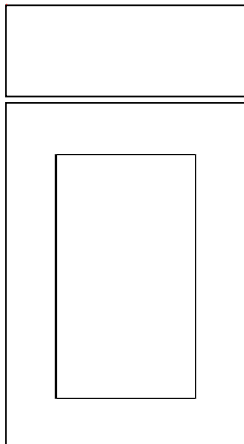
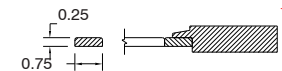

HEARTLAND (NC)

Drawer Front:

One piece, 3/4" thick, solid wood.

Door:

Solid wood frame, 3/4" x 3" wide. 1/2" solid wood insert.

Size Limits:

Door less than 7 1/2" wide will be one piece. Door greater than or equal to 44" high will have two inserts.

Maximum is 24" wide by 60" high.

PDF Size Limits:

Drawer fronts smaller than 4 1/2" in height will be one piece.

Drawer Front smaller than 8 3/4" in height will have 1 1/2" Rails.

Available Modifications:

PREP - Prep Door for Glass (NC)

MULL - Mullion Door (40%)

NCR - No Center Rail in Door (NC)

CR - Add Center Rail in Door (\$217.39)

PDF - Panel Drawer Front (3%)

PDFL - Panel Drawer Front, Large Only (3%)

Available Edge Profiles:

E5 E6 E13 E16 E34

Mullion Style:

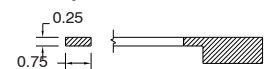

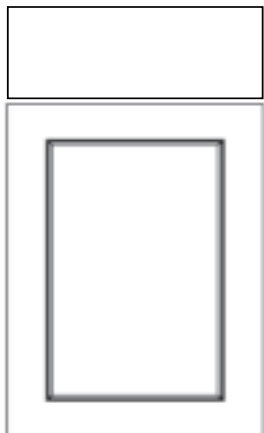

LAYTON (NC)

Drawer Front:

One piece, 3/4" thick, solid wood.

Door:

Solid wood frame, 3/4" x 2 1/4" wide stiles and 3/4" x 3" wide rails. 1/2" solid wood insert.

Size Limits:

Door less than 6 1/2" wide or high will be one piece.

Maximum is 24" wide by 60" high.

Door greater than or equal to 44" high will have two inserts.

Remarks:

Door is not available with two inserts.

PDF Size Limits:

Drawer fronts smaller than 4 1/4" in height will be one piece.

Drawer Front smaller than 8 1/4" in height will have 1 3/8" Rails.

Available Modifications:

PREP - Prep Door for Glass (NC)

MULL - Mullion Door (40%)

PDF - Panel Drawer Front (3%)

PDFL - Panel Drawer Front, Large Only (3%)

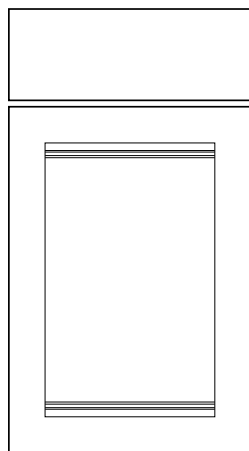
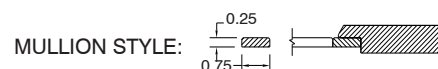

SERENITY (NC)

Drawer Front:

One piece, 3/4" thick, solid wood.

Door:

Solid wood frame, 3/4" x 2 1/4" wide stiles and 3/4" x 3" wide rails. 1/2" solid wood insert.

Size Limits:

Door less than 6 1/2" wide will be one piece.

Maximum is 24" wide by 60" high.

PDF Size Limits:

Drawer fronts smaller than 5 1/2" in height will be one piece.

Drawer Front smaller than 8 3/4" in height will have 1 3/4" Rails.

Remarks:

Door is not available with two inserts.

Available Modifications:

PREP - Prep Door for Glass (NC)

MULL - Mullion Door (40%)

PDF - Panel Drawer Front (3%)

PDFL - Panel Drawer Front, Large Only (3%)

Available Edge Profiles:

E5 E6 E13 E16 E34



Mullion Style:

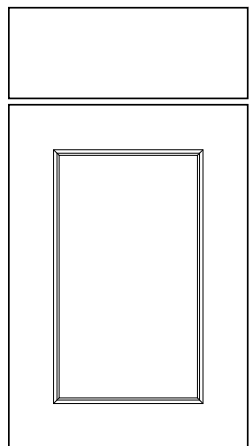
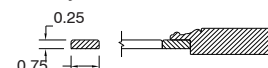

VILLA (5%)

Drawer Front:

One piece, 3/4" thick, solid wood.

Door:

Solid wood frame, 3/4" x 3" wide. 1/2" solid wood insert. French miter construction.

Size Limits:

Door less than 7 1/2" wide will be one piece. Maximum is 24" wide by 60" high.

PDF Size Limits:

Drawer fronts smaller than 4 1/2" in height will be one piece.

Drawer Front smaller than 8 3/4" in height will have 1 1/2" Rails.

Remarks:

Door is not available with two inserts.

Available Modifications:

PREP - Prep Door for Glass (NC)

MULL - Mullion Door (40%)

NCR - No Center Rail in Door (NC)

CR - Add Center Rail in Door (\$217.39)

PDF - Panel Drawer Front (3%)

PDFL - Panel Drawer Front, Large Only (3%)

Available Edge Profiles:

E5 E6 E13 E16 E34



Mullion Style:

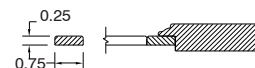

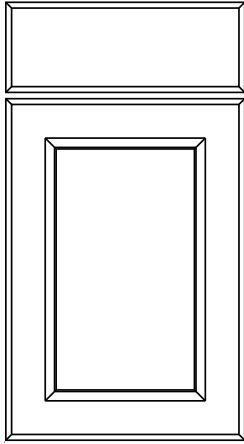

WARWICK (5%)

Drawer Front:

One piece, 7/8" thick, solid wood.

Door:

Solid wood frame, 7/8" x 3" wide. 1/2" solid wood insert. French miter construction.

Size Limits:

Door less than 8" wide will be one piece. Door greater than or equal to 44" high will have two inserts and 3" wide center rail.

Maximum size is 24" wide by 60" high.

PDF Size Limits:

Drawer fronts smaller than 5 1/2" in height will be one piece.

Drawer Front smaller than 8 3/4" in height will have 1 3/4" Rails.

Available Modifications:

PREP - Prep Door for Glass (NC)

MULL - Mullion Door (40%)

NCR - No Center Rail in Door (NC)

CR - Add Center Rail in Door (\$217.39)

PDF - Panel Drawer Front (3%)

PDFL - Panel Drawer Front, Large Only (3%)

Available Edge Profiles:

E5 E13 E16 E34

Remarks:

Not available as Inset door.

Mullion Style:

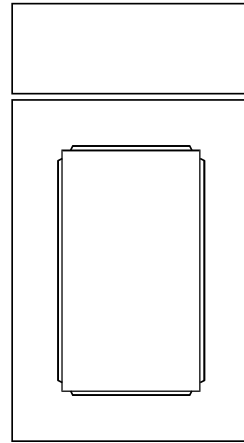
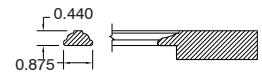

WESTPOINT (NC)

Drawer Front:

One piece, 3/4" thick, solid wood.

Door:

Solid wood frame, 3/4" x 3" wide. 1/2" solid wood insert.

Size Limits:

Door less than 7 1/2" wide will be one piece. Door greater than or equal to 44" high will have two inserts and 3" wide center rail.

Maximum size is 24" wide by 60" high.

PDF Size Limits:

Drawer fronts smaller than 4 1/2" in height will be one piece.

Drawer Front smaller than 8 3/4" in height will have 1 1/2" Rails.

Available Modifications:

PREP - Prep Door for Glass (NC)

MULL - Mullion Door (40%)

NCR - No Center Rail in Door (NC)

CR - Add Center Rail in Door (\$217.39)

PDF - Panel Drawer Front (3%)

PDFL - Panel Drawer Front, Large Only (3%)

Available Edge Profiles:

E5 E13 E16 E34

Mullion Style:

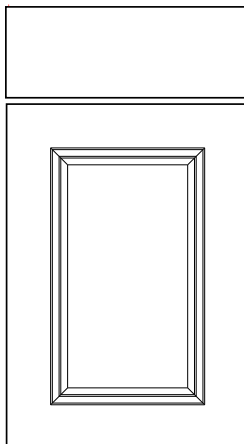
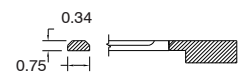

ASPEN (10%)

Drawer Front:

One piece, 3/4" thick, solid wood.

Door:

Solid wood frame, 3/4" x 3" wide. 1" molding is applied to the frame. 1/2" solid wood insert.

Size Limits:

Door less than 7 1/2" wide will be one piece. Door greater than or equal to 44" high will have two inserts. Maximum is 24" wide by 60" high.

PDF Size Limits:

Drawer fronts smaller than 4 1/2" in height will be one piece.

Drawer Front smaller than 8 3/4" in height will have 1 1/2" Rails.

Available Modifications:

PREP - Prep Door for Glass (NC)

MULL - Mullion Door (40%)

NCR - No Center Rail in Door (NC)

CR - Add Center Rail in Door (\$217.39)

PDF - Panel Drawer Front (3%)

PDFL - Panel Drawer Front, Large Only (3%)

Available Edge Profiles:

E5 E6 E13 E16 E34

Mullion Style:



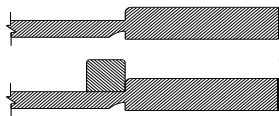
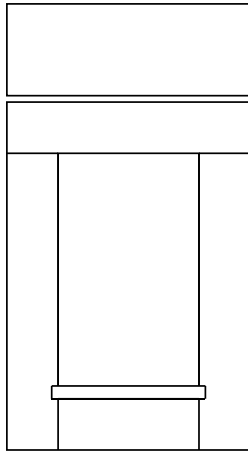

ATHENA (10%)

Drawer Front:

One piece, 3/4" thick, solid wood.

Door:

Solid wood frame, 3/4" x 3" wide. Frame has accent groove at joints. 3/4" molding is applied to bottom of frame. 1/2" solid wood insert.

Size Limits:

Door less than 7 1/2" wide will be one piece. Door greater than or equal to 44" high will have two inserts. Maximum size is 24" wide by 60" high.

PDF Size Limits:

Drawer fronts smaller than 4 1/2" in height will be one piece.
Drawer Front smaller than 8 3/4" in height will have 1 1/2" Rails.

Available Modifications:

- PREP - Prep Door for Glass (NC)
- NCR - No Center Rail in Door (NC)
- CR - Add Center Rail in Door (\$217.39)
- PDF - Panel Drawer Front (3%)
- PDFL - Panel Drawer Front, Large Only (3%)

Available Edge Profiles:

E5 E6 E13 E16

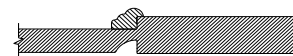
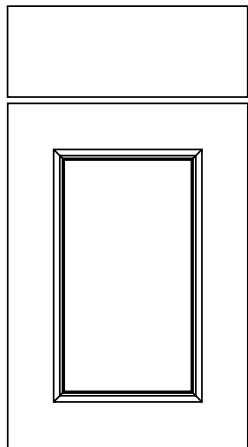

FREEMONT (10%)

Drawer Front:

One piece, 3/4" thick, solid wood.

Door:

Solid wood frame, 3/4" x 3" wide. 5/8" molding is applied to the frame. 1/2" solid wood insert.

Size Limits:

Door less than 7 1/2" wide will be one piece. Door greater than or equal to 44" high will have two inserts. Maximum is 24" wide by 60" high.

PDF Size Limits:

Drawer fronts smaller than 4 1/2" in height will be one piece.
Drawer Front smaller than 8 3/4" in height will have 1 1/2" Rails.

Available Modifications:

- PREP - Prep Door for Glass (NC)
- MULL - Mullion Door (40%)
- NCR - No Center Rail in Door (NC)
- CR - Add Center Rail in Door (\$217.39)
- PDF - Panel Drawer Front (3%)
- PDFL - Panel Drawer Front, Large Only (3%)

Available Edge Profiles:

E5 E6 E13 E16 E34

Mullion Style:

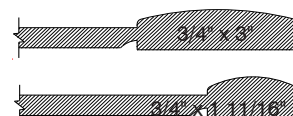
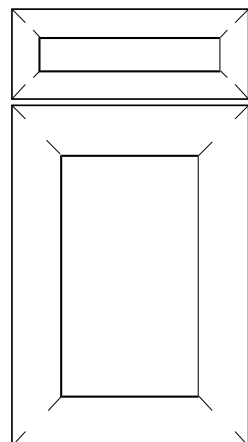
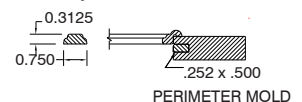

ANDOVER (15%)

Drawer Front:

Solid wood frame, 3/4" x 1 11/16" wide with 1/2" solid wood flat insert.

All large fronts will be the same style as doors.

Door:

Solid wood frame with mitered corners, 3/4" x 3" wide, 1/2" solid wood flat insert. Optional edge profile not available.

Size Limits:

Drawer less than 5 1/2" high will be one piece. Drawer less than or equal to 8" high will have a 1 11/16" wide frame. Drawer front greater than 8" high will have a 3" wide frame. Door less than 8" wide will be one piece. Maximum is 24" wide by 60" high.

PDF Size Limits:

Drawer less than 5 1/2" high will be one piece.
Drawer less than 8" high will have a 1 11/16" Stiles and Rails.
Drawer front greater than 8" high will have a 3" wide frame.
Maximum is 24" wide by 60" high.

Remarks:

Door is not available with two inserts. Not available as Inset door.

Available Modifications:

- PREP - Prep Door for Glass (NC)

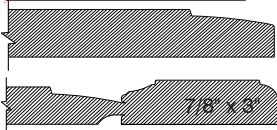
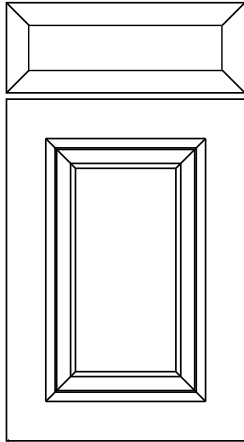

BELLEVILLE (5%)

Drawer Front:

One piece, 1" thick, solid wood.

Door:

Solid wood frame 7/8" x 3" wide. 3/4" solid wood insert. French miter construction.

Size Limits:

Door less than 8" wide will be one piece. Door less than 8 3/4" wide or high will have flat insert. Door greater than or equal to 44" high will have two inserts and 3" wide center rail. Maximum is 24" wide by 60" high.

PDF Size Limits:

Drawer fronts smaller than 5 1/2" in height will be one piece.

Drawer Front smaller than 8 3/4" in height will have 1 3/4" Rails.

Drawer Front 6 1/4" and smaller than in height will have a flat insert.

Remarks:

Not available as Inset door.

Available Modifications:

PREP - Prep Door for Glass (NC)

MULL - Mullion Door (40%)

PDF - Panel Drawer Front* (3%)

PDFL - Panel Drawer Front, Large Only (3%)

PDFF - Panel Drawer Front, Flat Insert (3%)

* Note:

Standard height drawer front will have a flat insert when specifying a Panel Drawer Front (PDF).

Available Edge Profiles:

E5	E13	E16	E34
----	-----	-----	-----

Mullion Style:

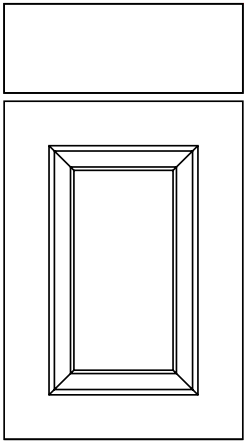
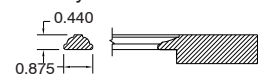

BENNINGTON (NC)

Drawer Front:

One piece, .3/4" thick, solid wood.

Door:

Solid wood frame, 3/4" x 3" wide. 3/4" solid wood insert.

Size Limits:

Door less than 7 1/2" wide will be one piece. Door less than 8 3/4" wide will have flat insert. Door greater than or equal to 44" high will have two inserts. Maximum size is 24" wide by 60" high.

PDF Size Limits:

Drawer fronts smaller than 4 1/2" in height will be one piece.

Drawer Front smaller than 8 3/4" in height will have 1 1/2" Rails.

Drawer Front 5 3/4" and smaller than in height will have a flat insert.

Available Modifications:

PREP - Prep Door for Glass (NC)

MULL - Mullion Door (40%)

NCR - No Center Rail in Door (NC)

CR - Add Center Rail in Door (\$217.39)

PDF - Panel Drawer Front (3%)

PDFL - Panel Drawer Front, Large Only (3%)

PDFF - Panel Drawer Front, Flat Insert (3%)

Available Edge Profiles:

E5	E6	E13	E16	E34
----	----	-----	-----	-----

Mullion Style:

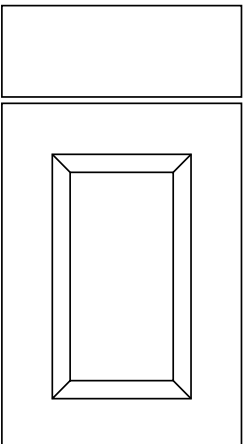
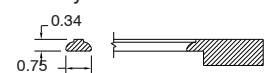

BERKLEY (NC)

Drawer Front:

One piece, 3/4" thick, solid wood.

Door:

Solid wood frame, 3/4" x 3" wide. 3/4" solid wood insert.

Size Limits:

Door less than 7 1/2" wide will be one piece. Door less than 8 3/4" wide will have flat insert. Door greater than or equal to 44" high will have two inserts. Maximum size is 24" wide by 60" high.

PDF Size Limits:

Drawer fronts smaller than 4 1/2" in height will be one piece.

Drawer Front smaller than 8 3/4" in height will have 1 1/2" Rails.

Drawer Front 5 3/4" and smaller than in height will have a flat insert.

Available Modifications:

PREP - Prep Door for Glass (NC)

MULL - Mullion Door (40%)

NCR - No Center Rail in Door (NC)

CR - Add Center Rail in Door (\$217.39)

PDF - Panel Drawer Front (3%)

PDFL - Panel Drawer Front, Large Only (3%)

PDFF - Panel Drawer Front, Flat Insert (3%)

Available Edge Profiles:

E5	E6	E13	E16	E34
----	----	-----	-----	-----

Mullion Style:

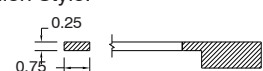

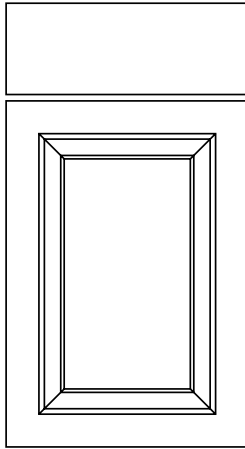

BRECKENRIDGE (NC)

Drawer Front:

One piece, 3/4" thick, solid wood.

Door:

Solid wood frame, 3/4" x 2 1/4" wide. 3/4" solid wood insert.

Size Limits:

Door less than 6" wide will be one piece. Door less than 7 1/4" wide will have flat insert. Door greater than or equal to 44" high will have two inserts. Maximum size is 24" wide by 60" high.

PDF Size Limits:

Drawer fronts smaller than 4 1/2" in height will be one piece.

Drawer Front smaller than 7 1/4" in height will have 1 1/2" Rails.

Drawer Front 5 3/4" and smaller than in height will have a flat insert.

Available Modifications:

PREP - Prep Door for Glass (NC)

MULL - Mullion Door (40%)

NCR - No Center Rail in Door (NC)

CR - Add Center Rail in Door (\$217.39)

PDF - Panel Drawer Front (3%)

PDFL - Panel Drawer Front, Large Only (3%)

PDFF - Panel Drawer Front, Flat Insert (3%)

Available Edge Profiles:

E5	E6	E13	E16	E34
----	----	-----	-----	-----

Mullion Style:

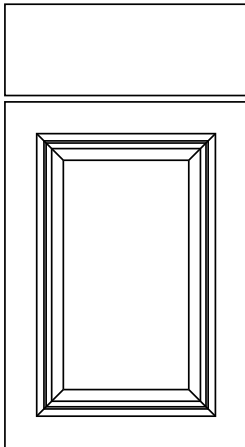
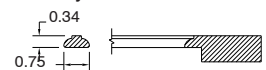

CEDAR CREST (5%)

Drawer Front:

One piece, 3/4" thick, solid wood.

Door:

Solid wood frame, 3/4" x 2 3/4" wide. 3/4" solid wood insert. French miter construction.

Size Limits:

Door less than 7" wide will be one piece. Door less than 8 1/4" wide or high will have flat insert. Door greater than or equal to 44" high will have two inserts and 3.3098" wide center rail.

Maximum size is 24" wide by 60" high.

PDF Size Limits:

Drawer fronts smaller than 4 1/2" in height will be one piece.

Drawer Front smaller than 8 1/4" in height will have 1 1/2" Rails.

Drawer Front 5 3/4" and smaller than in height will have a flat insert.

Available Modifications:

PREP - Prep Door for Glass (NC)

MULL - Mullion Door (40%)

NCR - No Center Rail in Door (NC)

CR - Add Center Rail in Door (\$217.39)

PDF - Panel Drawer Front (3%)

PDFL - Panel Drawer Front, Large Only (3%)

Available Edge Profiles:

E5	E6	E13	E16	E34
----	----	-----	-----	-----

Mullion Style:

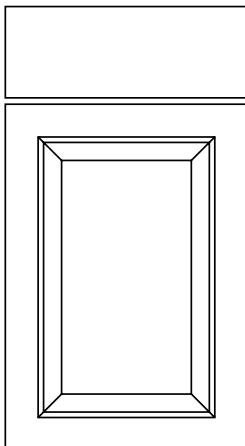
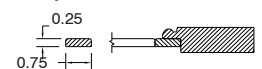

COLONIAL (NC)

Drawer Front:

One piece, 3/4" thick, solid wood.

Door:

Solid wood frame, 3/4" x 2 1/4" wide. 3/4" solid wood insert.

Size Limits:

Door less than 6" wide will be one piece. Door less than 7 1/4" wide will have flat insert. Door greater than or equal to 44" high will have two inserts. Maximum size is 24" wide by 60" high.

PDF Size Limits:

Drawer fronts smaller than 4 1/2" in height will be one piece.

Drawer Front smaller than 7 1/4" in height will have 1 1/2" Rails.

Drawer Front 5 3/4" and smaller than in height will have a flat insert.

Available Modifications:

PREP - Prep Door for Glass (NC)

MULL - Mullion Door (40%)

NCR - No Center Rail in Door (NC)

CR - Add Center Rail in Door (\$217.39)

PDF - Panel Drawer Front (3%)

PDFL - Panel Drawer Front, Large Only (3%)

PDFF - Panel Drawer Front, Flat Insert (3%)

Available Edge Profiles:

E5	E6	E13	E16	E34
----	----	-----	-----	-----

Mullion Style:

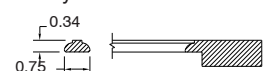

Door Styles

Door Styles

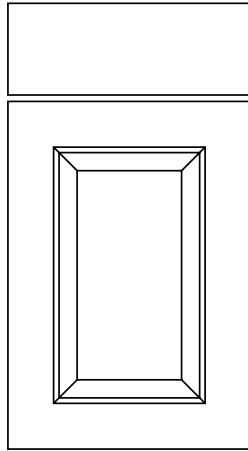

CRAWFORD (NC)

Drawer Front:

One piece, 3/4" thick, solid wood.

Door:

Solid wood frame, 3/4" x 3" wide. 3/4" solid wood insert.

Size Limits:

Door less than 7 1/2" wide will be one piece. Door less than 8 3/4" wide will have flat insert. Door greater than or equal to 44" high will have two inserts. Maximum size is 24" wide by 60" high.

PDF Size Limits:

Drawer fronts smaller than 4 1/2" in height will be one piece.
Drawer Front smaller than 8 3/4" in height will have 1 1/2" Rails.
Drawer Front 5 3/4" and smaller than in height will have a flat insert.

Available Modifications:

- PREP - Prep Door for Glass (NC)
- MULL - Mullion Door (40%)
- NCR - No Center Rail in Door (NC)
- CR - Add Center Rail in Door (\$217.39)
- PDF - Panel Drawer Front (3%)
- PDFL - Panel Drawer Front, Large Only (3%)
- PDFF - Panel Drawer Front, Flat Insert (3%)

Available Edge Profiles:

E5 E6 E13 E16 E34

Mullion Style:

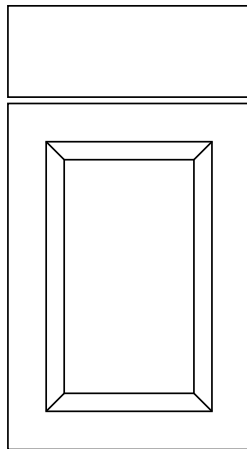
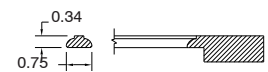

HIGHLAND (NC)

Drawer Front:

One piece, 3/4" thick, solid wood.

Door:

Solid wood frame, 3/4" x 2 1/4" wide. 3/4" solid wood insert.

Size Limits:

Door less than 6" wide will be one piece. Door less than 7 1/4" wide will have flat insert. Door greater than or equal to 44" high will have two inserts. Maximum size is 24" wide by 60" high.

PDF Size Limits:

Drawer fronts smaller than 4 1/2" in height will be one piece.
Drawer Front smaller than 7 1/4" in height will have 1 1/2" Rails.
Drawer Front 5 3/4" and smaller than in height will have a flat insert.

Available Modifications:

- PREP - Prep Door for Glass (NC)
- MULL - Mullion Door (40%)
- NCR - No Center Rail in Door (NC)
- CR - Add Center Rail in Door (\$217.39)
- PDF - Panel Drawer Front (3%)
- PDFL - Panel Drawer Front, Large Only (3%)
- PDFF - Panel Drawer Front, Flat Insert (3%)

Available Edge Profiles:

E5 E6 E13 E16 E34

Mullion Style:

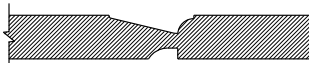
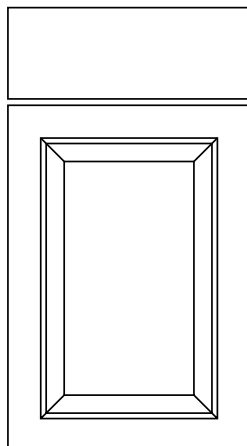
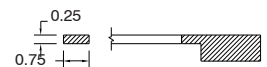

JAMESTOWN (NC)

Drawer Front:

One piece, 3/4" thick, solid wood.

Door:

Solid wood frame, 3/4" x 2 1/4" wide. 3/4" solid wood insert.

Size Limits:

Door less than 6" wide will be one piece. Door less than 7 1/4" wide will have flat insert. Door greater than or equal to 44" high will have two inserts. Maximum size is 24" wide by 60" high.

PDF Size Limits:

Drawer fronts smaller than 4 1/2" in height will be one piece.
Drawer Front smaller than 7 1/4" in height will have 1 1/2" Rails.
Drawer Front 5 3/4" and smaller than in height will have a flat insert.

Available Modifications:

- PREP - Prep Door for Glass (NC)
- MULL - Mullion Door (40%)
- NCR - No Center Rail in Door (NC)
- CR - Add Center Rail in Door (\$217.39)
- PDF - Panel Drawer Front (3%)
- PDFL - Panel Drawer Front, Large Only (3%)
- PDFF - Panel Drawer Front, Flat Insert (3%)

Available Edge Profiles:

E5 E6 E13 E16 E34

Mullion Style:

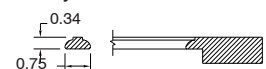

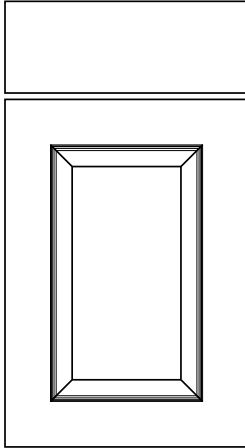

LINDSEY (5%)

Drawer Front:

One piece, 3/4" thick, solid wood.

Door:

Solid wood frame 3/4" x 3" wide. 3/4" solid wood insert.

Size Limits:

Door less than 7 1/2" wide will be one piece. Door less than 8 3/4" will have flat insert.

Maximum size is 24" wide by 60" high.

PDF Size Limits:

Drawer fronts smaller than 4 1/2" in height will be one piece.

Drawer Front smaller than 8 3/4" in height will have 1 1/2" Rails.

Drawer Front 5 3/4" and smaller than in height will have a flat insert.

Remarks:

Door is not available with two inserts.

Available Modifications:

PREP - Prep Door for Glass (NC)

MULL - Mullion Door (40%)

PDF - Panel Drawer Front (3%)

PDFL - Panel Drawer Front, Large Only (3%)

PDFF - Panel Drawer Front, Flat Insert (3%)

Available Edge Profiles:

E5 E6 E13 E16 E34

Mullion Style:

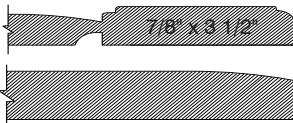
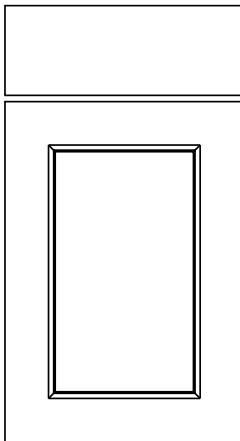
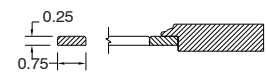

MAYFIELD (5%)

Drawer Front:

One piece, 1" thick, solid wood.

Panel Drawer Fronts will have edge profile to match door. E5

Door:

Solid wood frame 7/8" x 3 1/2" wide. 3/4" solid wood insert. French miter construction.

Size Limits:

Door less than 8 1/2" wide will be one piece. Door less than 9 3/4" wide or high will have flat insert.

Maximum is 24" wide by 60" high.

PDF Size Limits:

Drawer fronts smaller than 6 3/8" in height will be one piece.

Drawer Front smaller than 8 3/4" in height will have 1 1/2" Rails.

Remarks:

Door is not available with two inserts. Not available as Inset door.

Available Modifications:

PREP - Prep Door for Glass (NC)

PDF - Panel Drawer Front* (3%)

PDFL - Panel Drawer Front, Large Only (3%)

Available Edge Profiles:

E5 E13 E16 E34

* Note:

Standard height drawer front will have a flat insert when specifying a Panel Drawer Front (PDF).

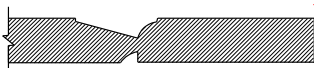
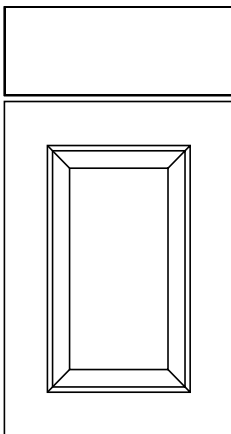

PRESCOTT (NC)

Drawer Front:

One piece, 3/4" thick, solid wood.

Door:

Solid wood frame, 3/4" x 3" wide. 3/4" solid wood insert.

Size Limits:

Door less than 7 1/2" wide will be one piece. Door less than 8 3/4" wide will have flat insert. Door greater than or equal to 44" high will have two inserts. Maximum size is 24" wide by 60" high.

PDF Size Limits:

Drawer fronts smaller than 4 1/2" in height will be one piece.

Drawer Front smaller than 8 3/4" in height will have 1 1/2" Rails.

Drawer Front 5 3/4" and smaller than in height will have a flat insert.

Available Modifications:

PREP - Prep Door for Glass (NC)

MULL - Mullion Door (40%)

NCR - No Center Rail in Door (NC)

CR - Add Center Rail in Door (\$217.39)

PDF - Panel Drawer Front (3%)

PDFL - Panel Drawer Front, Large Only (3%)

PDFF - Panel Drawer Front, Flat Insert (3%)

Available Edge Profiles:

E5 E6 E13 E16 E34

Mullion Style:

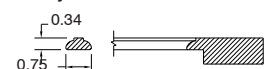

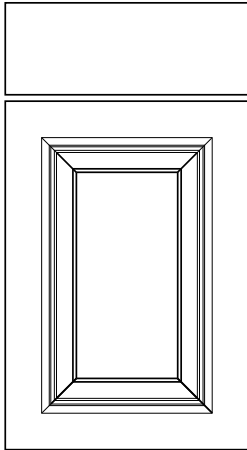

WAKEFIELD (5%)

Drawer Front:

One piece, 3/4" thick, solid wood.

Door:

Solid wood frame 3/4" x 3" wide. 3/4" solid wood insert. French miter construction.

Size Limits:

Door less than 8" wide will be one piece. Door less than 8 3/4" wide will have a flat insert. Door greater than or equal to 44" high will have two inserts and 3 3/4" wide center rail.

Maximum size is 24" wide by 60" high.

PDF Size Limits:

Drawer fronts smaller than 5 11/16" in height will be one piece.

Drawer Front smaller than 8 3/4" in height will have 1 11/16" Rails.

Drawer Front 6 1/8" and smaller than in height will have a flat insert.

Available Modifications:

PREP - Prep Door for Glass (NC)

MULL - Mullion Door (40%)

NCR - No Center Rail in Door (NC)

CR - Add Center Rail in Door (\$217.39)

PDF - Panel Drawer Front (3%)

PDFL - Panel Drawer Front, Large Only (3%)

Available Edge Profiles:

E5 E6 E13 E16 E34

Mullion Style:

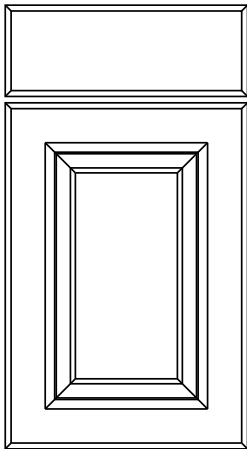
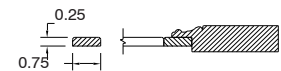

WELLINGTON (5%)

Drawer Front:

One piece, 7/8" thick, solid wood.

Door:

Solid wood frame, 7/8" x 3" wide. 3/4" solid wood insert. French miter construction.

Size Limits:

Door less than 8" wide will be one piece. Door less than 8 3/4" wide or high will have flat insert. Door greater than or equal to 44" high will have two inserts and 3" wide center rail.

Maximum size is 24" wide by 60" high.

PDF Size Limits:

Drawer fronts smaller than 5 1/2" in height will be one piece.

Drawer Front smaller than 8 3/4" in height will have 1 3/4" Rails.

Drawer Front 6 1/4" and smaller than in height will have a flat insert.

Available Modifications:

PREP - Prep Door for Glass (NC)

MULL - Mullion Door (40%)

NCR - No Center Rail in Door (NC)

CR - Add Center Rail in Door (\$217.39)

PDF - Panel Drawer Front* (3%)

PDFL - Panel Drawer Front, Large Only (3%)

Available Edge Profiles:

E5 E13 E16 E34

Remarks:

Not available as Inset door.

* Note:

Standard height drawer front will have a flat insert when specifying a Panel Drawer Front (PDF).

Mullion Style:

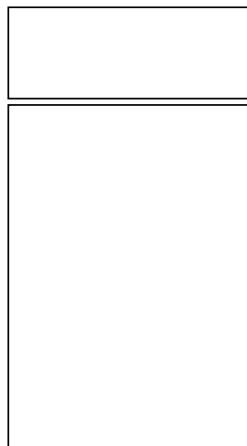
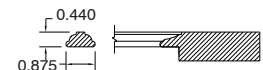

BELMONT 1 (Solid MDF Door) (NC)

Drawer Front:

One piece, 3/4" medium density fiberboard.

Door:

One piece, 3/4" medium density fiberboard.

Size Limits:

Maximum size is 24" wide by 60" high.

Remarks:

Doors with mullions are four piece, solid wood frame construction. Finishes available are Opaque colors only.

Available Modifications:

PREP - Prep Door for Glass (NC)

MULL - Mullion Door (40%)

Available Edge Profiles:

E6

Mullion Style:

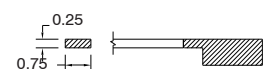

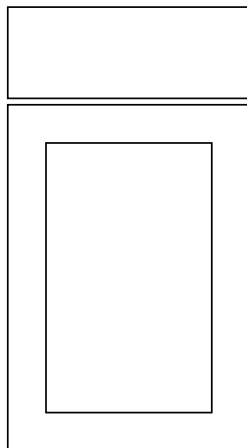

FAIRFIELD-MDF (NC)

Drawer Front:

One piece, 3/4" thick, MDF.

Door:

MDF frame, 3/4" x 2 1/4" wide. 1/2" MDF insert.

Size Limits:

Door less than 6" wide will be one piece. Door greater than or equal to 44" high will have two inserts. Maximum is 24" wide by 60" high.

PDF Size Limits:

Drawer fronts smaller than 4 1/2" in height will be one piece.

Drawer Front smaller than 7 1/4" in height will have 1 1/2" Rails.

Available Modifications:

PREP - Prep Door for Glass (NC)

MULL - Mullion Door (40%)

NCR - No Center Rail in Door (NC)

CR - Add Center Rail in Door (\$217.39)

PDF - Panel Drawer Front (3%)

PDFL - Panel Drawer Front, Large Only (3%)

Available Edge Profiles:

E6

Mullion Style:

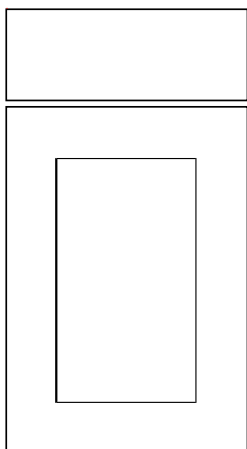
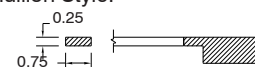

HEARTLAND-MDF (NC)

Drawer Front:

One piece, 3/4" thick, MDF.

Door:

MDF frame, 3/4" x 3" wide. 1/2" MDF insert.

Size Limits:

Door less than 7 1/2" wide will be one piece. Door greater than or equal to 44" high will have two inserts. Maximum is 24" wide by 60" high.

PDF Size Limits:

Drawer fronts smaller than 4 1/2" in height will be one piece.

Drawer Front smaller than 8 3/4" in height will have 1 1/2" Rails.

Available Modifications:

PREP - Prep Door for Glass (NC)

MULL - Mullion Door (40%)

NCR - No Center Rail in Door (NC)

CR - Add Center Rail in Door (\$217.39)

PDF - Panel Drawer Front (3%)

PDFL - Panel Drawer Front, Large Only (3%)

Available Edge Profiles:

E6

Mullion Style:

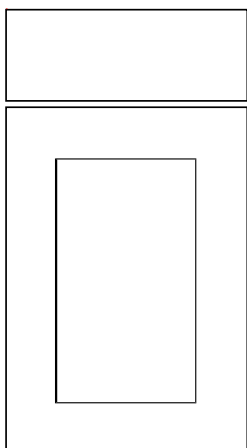
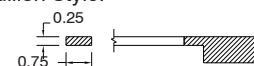

CRANBROOKE-MDF (NC)

Drawer Front:

One piece, 3/4" thick, MDF.

Door:

MDF frame, 3/4" x 3" wide. 1/2" MDF insert.

Size Limits:

Door less than 7 1/2" wide will be one piece. Door greater than or equal to 44" high will have two inserts. Maximum is 24" wide by 60" high.

PDF Size Limits:

Drawer fronts smaller than 4 1/2" in height will be one piece.

Drawer Front smaller than 8 3/4" in height will have 1 1/2" Rails.

Available Modifications:

PREP - Prep Door for Glass (NC)

MULL - Mullion Door (40%)

NCR - No Center Rail in Door (NC)

CR - Add Center Rail in Door (\$217.39)

PDF - Panel Drawer Front (3%)

PDFL - Panel Drawer Front, Large Only (3%)

Available Edge Profiles:

E6

Mullion Style:

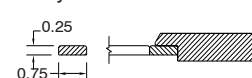

Door Styles

Door Styles

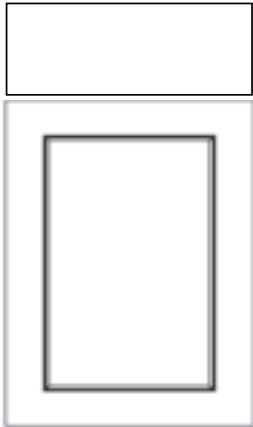

LAYTON-MDF (NC)

Drawer Front:

One piece, 3/4" thick, MDF.

Door:

MDF frame, 3/4" x 2 1/4" wide stiles and 3/4" x 3" wide rails. 1/2" MDF insert.

Size Limits:

Door less than 6 1/2" wide or high will be one piece.

Maximum is 24" wide by 60" high.

Door greater than or equal to 44" high will have two inserts.

Remarks:

Door is not available with two inserts.

PDF Size Limits:

Drawer fronts smaller than 4 1/4" in height will be one piece.

Drawer Front smaller than 8 1/4" in height will have 1 3/8" Rails.

Available Modifications:

PREP - Prep Door for Glass (NC)

MULL - Mullion Door (40%)

PDF - Panel Drawer Front (3%)

PDFL - Panel Drawer Front, Large Only (3%)

Available Edge Profiles:

E6

MULLION STYLE:

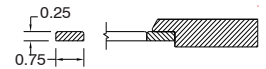

ALDER (7%) hardwood is a closed or tight grain wood. It has a hardness comparable to cherry. Alder is pale pinkish-brown to almost white in color. Grain can contain mineral streaks, gum spots, small knots, and pin holes that are not defects, but are characteristic of the wood. Common are soft grain pockets causing blotchy areas visible when stain is applied. Veneer is plain slice and plank match.

WARNING: If you select a light stain, natural finish or unfinished, these selections will produce cabinetry with the highest level of variability in appearance. While this is desired by some customers, some customers may be objectionable to the varying appearance. To ensure your customers satisfaction, we encourage you to have them sign off on the finish waiver provided in this catalog.

BEECH (NC) hardwood is a closed, generally straight grained wood with broad rays, and fine, even texture. Beech wood is pale cream to pinkish brown heartwood that darkens to a pale reddish brown. Veneer is plain slice and book match.

WARNING: If you select a light stain, natural finish or unfinished, these selections will produce cabinetry with the highest level of variability in appearance. While this is desired by some customers, some customers may be objectionable to the varying appearance. To ensure your customers satisfaction, we encourage you to have them sign off on the finish waiver provided in this catalog.

CHERRY (7%) hardwood is a closed, richly grained wood with a smooth texture. Cherry has a pinkish-brown hue and can exhibit shades of white, yellow, red, and brown. Black mineral streaks and gum spots are characteristic of cherry wood. Depending on the amount of exposure to light, the red and brown colors in cherry will darken naturally in a very short period of time. Veneer is plain slice and plank match.

WARNING: If you select a light stain, natural finish or unfinished, these selections will produce cabinetry with the highest level of variability in appearance. While this is desired by some customers, some customers may be objectionable to the varying appearance. To ensure your customers satisfaction, we encourage you to have them sign off on the finish waiver provided in this catalog.

HICKORY (5%) hardwood is an open grain wood with excellent resistance to shock. Wild variations in color, grain, and mineral streaks are characteristics of this wood. Hickory has streaks of sap that can exhibit shades of white, yellow, red, and brown. Veneer is plain slice and plank match.

WARNING: If you select a light stain, natural finish or unfinished, these selections will produce cabinetry with the highest level of variability in appearance. While this is desired by some customers, some customers may be objectionable to the varying appearance. To ensure your customers satisfaction, we encourage you to have them sign off on the finish waiver provided in this catalog.

KNOTTY ALDER (-5%) hardwood is a closed or tight grain wood. It has a hardness comparable to cherry. Knotty Alder is pale pinkish-brown to almost white in color. Grain can contain mineral streaks, open and closed knots, gum spots, and small pin holes that are not defects, but are characteristic of the wood. Common are soft grain pockets causing blotchy areas visible when stain is applied. Veneer is plain slice and plank match.

WARNING: If you select a light stain, natural finish or unfinished, these selections will produce cabinetry with the highest level of variability in appearance. While this is desired by some customers, some customers may be objectionable to the varying appearance. To ensure your customers satisfaction, we encourage you to have them sign off on the finish waiver provided in this catalog.

QUARTER SAWN SAPELE (15%) hardwood is a high grade African Sapele. The wood grain is fine textured and quarter sawn. Sapele is medium to dark brown or reddish-brown. The wood can exhibit some sapwood in shades of white or yellow. Depending on the amount of exposure to light, the color in sapele will darken naturally in a very short period of time. Veneer is quarter slice and book match.

WARNING: If you select a light stain, natural finish or unfinished, these selections will produce cabinetry with the highest level of variability in appearance. While this is desired by some customers, some customers may be objectionable to the varying appearance. To ensure your customers satisfaction, we encourage you to have them sign off on the finish waiver provided in this catalog.

MAPLE (NC) hardwood is a closed grain wood with smooth, fine grain patterns. Grey mineral streaks commonly occur in maple. The hardwood has excellent resistance to shock. Veneer is plain slice and plank match.

WARNING: If you select a light stain, natural finish or unfinished, these selections will produce cabinetry with the highest level of variability in appearance. While this is desired by some customers, some customers may be objectionable to the varying appearance. To ensure your customers satisfaction, we encourage you to have them sign off on the finish waiver provided in this catalog.

OAK (NC) hardwood is a high grade northern red oak. The wood has an open grain which varies from vertical to a sweeping arch pattern. Oak will vary in natural tints and shades of white, pink, grey, and green. Veneer is plain slice and plank match.

WARNING: If you select a light stain, natural finish or unfinished, these selections will produce cabinetry with the highest level of variability in appearance. While this is desired by some customers, some customers may be objectionable to the varying appearance. To ensure your customers satisfaction, we encourage you to have them sign off on the finish waiver provided in this catalog.

QUARTER SAWN WHITE OAK (20%) hardwood is a high grade northern white oak. The wood grain is open, but very fine. The fine grain is made by quarter-sawing, making the cut parallel with the medullary ray cells, and preserving them along with the fine grain. Some wide grains will show up with the fine. The medullary rays may vary from small to large. Veneer is quarter slice and book match.

WARNING: If you select a light stain, natural finish or unfinished, these selections will produce cabinetry with the highest level of variability in appearance. While this is desired by some customers, some customers may be objectionable to the varying appearance. To ensure your customers satisfaction, we encourage you to have them sign off on the finish waiver provided in this catalog.

WALNUT (25%) hardwood varies from very straight grained to interlocked grain which produces pronounced figure and exhibits a cathedral pattern. Walnut is defined by its rich deep browns and beautiful figure. The lumber has natural color variation ranging from dark to lighter browns with blond or white sapwood. Pin knots with small dark centers may be prevalent. Depending on the amount of exposure to light, walnut will mellow and lighten naturally in a very short period of time. Veneer is plain slice and plank match.

WARNING: If you select a light stain, natural finish or unfinished, these selections will produce cabinetry with the highest level of variability in appearance. While this is desired by some customers, some customers may be objectionable to the varying appearance. To ensure your customers satisfaction, we encourage you to have them sign off on the finish waiver provided in this catalog.

RUSTIC WOODS

RUSTIC BEECH (NC) hardwood has been modified and may contain mineral streaks, gum spots, sap and open and closed knots. Does not affect veneered parts.

WARNING: If you select a light stain, natural finish or unfinished, these selections will produce cabinetry with the highest level of variability in appearance. While this is desired by some customers, some customers may be objectionable to the varying appearance. To ensure your customers satisfaction, we encourage you to have them sign off on the finish waiver provided in this catalog.

RUSTIC HICKORY (5%) hardwood has been modified and may contain mineral streaks, gum spots, sap and open and closed knots. Does not affect veneered parts.

WARNING: If you select a light stain, natural finish or unfinished, these selections will produce cabinetry with the highest level of variability in appearance. While this is desired by some customers, some customers may be objectionable to the varying appearance. To ensure your customers satisfaction, we encourage you to have them sign off on the finish waiver provided in this catalog.

RUSTIC CHERRY (7%) hardwood has been modified and may contain mineral streaks, gum spots, sap and open and closed knots. Face Frame and moldings will have minimal to no knots. Does not affect veneered parts.

WARNING: If you select a light stain, natural finish or unfinished, these selections will produce cabinetry with the highest level of variability in appearance. While this is desired by some customers, some customers may be objectionable to the varying appearance. To ensure your customers satisfaction, we encourage you to have them sign off on the finish waiver provided in this catalog.

We call your attention to these natural characteristics in the different wood species. Crestwood cannot be held responsible for the degree of variation you will experience in real wood. UNUSUAL GRAINING AND REASONABLE VARIATION IN COLOR WILL NOT BE CAUSE FOR REPLACEMENT.

DISTRESSED (DIST) (4% up charge) treatment is achieved by randomly distressing the wood with dents before finishing. Distressing is more pronounced on hardwood with less density.

HEAVY DISTRESSED (HDIST) (15% up charge) treatment is achieved by randomly distressing the wood with light dents. The wood is further distressed by a variety of heavy dents before finishing. Distressing is more pronounced on hardwood with less density.

KNIFE CUTS (KCUT) (4% up charge) are simulated cracks of varied lengths. This is achieved by randomly cutting the wood on door and drawer fronts.

WORM HOLES (WHOL) (4% up charge) are achieved by randomly marking the wood with small pin holes. Pin holes are scattered in small clusters to give a natural, rustic look.

VINTAGE (VINT) (8% up charge) treatment is achieved by oversanding the wood before finishing then further distressing with random highlight burn. **Oversanding** (simulated areas of natural wear) is done on doors, drawer fronts, moldings and loose accessories only. The wood is then finished with a finish color and seal coat and edges of **Oversanding** are lightly sanded again creating random **Highlight Burns** (areas where the finish has been worn through). This wear through process is protected with a clear topcoat.

COUNTRY (CTRY) (8% up charge) treatment is a combination of **Distress** and **Vintage** wood treatments.

OLD WORLD (OLDW) (20% up charge) treatment is a combination of **Country**, **Knife Cuts**, and **Worm Holes** wood treatments and a variety of additional marks. These marks are created by randomly **chipping** (tear out) the edges and surface, **rasping** (simulated saw marks) the edges, and **peppering** (very tiny, lightly patterned holes) the surface.

RENAISSANCE (RNAS) (22% up charge) treatment consists of heavy hand **Distressing**, heavy **Chiseling**, deep **Knife Cuts**, **Worm Holes**, **Oversanding** on edges and **Highlight Burn**.

CAUTION should be taken when specifying wood treatment. Distressing is an artistic process which will create noticeable variations in patterns and oversanding on individual pieces. These techniques are more pronounced on the softer woods. We recommend viewing a sample door, in the wood and finish you are considering, prior to ordering. The more processes involved in wood treatment, the more radical the representation of marks from sample door to sample door.

Although we strive to reproduce a reasonable facsimile of the wood treatments, be aware that the process is an art form. A sample door is only a snapshot in time. Each artist will add his or her own flair, which will individualize every job.

UNFINISHED: (-15% up charge) Woods will not have stain, sealer, or topcoat applied. Cabinet interior, including standard wood accessories such as shelves, drawers, and pull-out trays, will remain prefinished. Unfinished wood is not guaranteed against warpage.

NATURAL: (NC) Finished wood will not have stain but will have a clear sealer and topcoat applied. The clear finished wood will exhibit more color change and variation than wood with an opaque or dark finish. These exposed variations should not be considered reason for replacement. We recommend that a letter of understanding be sent to your customer.

STAINED FINISHES: (NC) Stains are sprayed over the surface and then wiped by hand to create deep, rich color and enhance the grain. Stained finishes are protected with a high solids two-part acrylic polyurethane chosen for its exceptional durability and beauty.

OPAQUE FINISHES: (8% up charge) Opaque colors are obtained by applying a two-part polyurethane primer and one coat of pigmented two-part polyurethane on "paintable" species (paint grade maple is used for solid wood components and a smooth, paintable surface is used for panel components). CAUTION should be taken when specifying opaque colors. All wood joints will develop cracks due to the natural process of expansion and contraction of wood. These cracks are more visible with opaque colors. All wood will visually telegraph some wood texture with opaque colors. Therefore, open grain woods will be very visible. The darker opaque colors may show hairline checking in the topcoat when applied to wood veneers. It is also more difficult to hide joints when cutting prefinished moldings. The polyurethane finish is highly resistant to household chemicals, water, alcohol, and mild acids.

OPAQUE/GLAZE FINISHES: (28% up charge) This is a selection of opaque colors with a glaze. The glaze is applied over the opaque color. These glazing processes are not applied to the backside of doors and drawer fronts. Glazes are intended to have a very inconsistent look. Build up in corners and profiles may range from heavy to nonexistent. Brush marks may lap at wood joints. We recommend viewing a sample door in the style you prefer to see total effect of the glazing. Although we strive to reproduce facsimile of the glazes and special finishes, be aware that the finish process is an art form. A sample door is only a snapshot in time. Each artist will add his or her own flair, which will individualize every job. The finish waiver, located on the last page of this catalog, must be signed and on file with Crestwood before any opaque/glaze finish order can be confirmed and scheduled into production.

STATEMENT FINISHES: (See chart for up Charge) Statement Finishes are created with layers of finish colors, glaze and hand-distressing techniques to create a realistic hand rubbed and worn look. Glazing is an artistic technique and are intended to have a very inconsistent look. Build up in corners and profiles may range from heavy to nonexistent. We recommend viewing a sample door in the style you prefer to see total effect of the glazing. Although we strive to reproduce facsimile of the glazes and special finishes, be aware that the finish process is an art form. A sample door is only a snapshot in time. Each artist will add his or her own flair, which will individualize every job. The finish waiver, located on the last page of this catalog, must be signed and on file with Crestwood before any statement finish order can be confirmed and scheduled into production.

ACCENT GLAZES: (8% up charge) Glaze is bottled into profiles after the stain and topcoat.

FAN DECK SOLID COLORS: (13% up charge) Produced by matching, as close as possible, a solid paint color from either Sherwin Williams™ or Benjamin Moore™ fan decks for a discounted price from a custom solid color. Provide paint brand, color name and color number desired. The new color will be assigned a special control number. Sample will be shipped for customer approval. Match fee is \$150.00

		ALDER	BEECH/ R BEECH	CHERRY/ R CHERRY	HICKORY/ R HICKORY	K ALDER	QS SAPELE	MAPLE	PMAPLE	OAK	QS WHITE OAK	WALNUT	
ACCENT GLAZE AVAILABLE ON ANY STAIN: A-BL (black) A-BR (brown) A-GR (gray) A-MO (mocha)	STAINS (NC)												
	NATURAL - SATIN	●	●	●	●	●	●	●		●	●	●	
	NATURAL - FLAT	●	●	●	●	●	●	●		●	●	●	
	BAILEY	●	●	●	●	●	●	●		●	●	●	
	BASALT	●	●	●	●	●	●	●		●	●	●	
	BOURBON	●	●	●	●	●	●	●		●	●	●	
	CARBON	●	●	●	●	●	●	●		●	●	●	
	GUINNESS	●	●	●	●	●	●	●		●	●	●	
	HEATHER	●	●	●	●	●	●	●		●	●	●	
	HENNESSY	●	●	●	●	●	●	●		●	●	●	
	MARJORAM	●	●	●	●	●	●	●		●	●	●	
	SESAME SEED	●	●	●	●	●	●	●		●	●	●	
OPAQUES (8% UC)	CHAMPAGNE								●				
	DOVE								●				
	ECLIPSE								●				
	FOG								●				
	ICEBERG								●				
	ICING								●				
	LINEN								●				
	NIGHT SKY								●				
	PEBBLE								●				
	PORCH SWING								●				
	RAVEN								●				
	RIVER ROCK								●				
	SOLITAIRE								●				
	THISTLEDOWN								●				
	TUXEDO								●				
TWILIGHT								●					
FINISH WAIVER REQUIRED	OPAQUE/GLAZES (28% UC)												
	BOTTICELLI								●				
	DA VINCI								●				
	GAUGUIN								●				
	MATISSE								●				
	MICHELANGELO								●				
	RAPHAEL								●				
FINISH WAIVER REQUIRED	STATEMENTS												
	EBONY (20% UC)	●				●						●	
	FOREST (15% UC)		●		●							●	
	MOREL (15% UC)		●		●							●	
	TUNDRA (15% UC)		●		●							●	
	CASCADE (15% UC)		●		●							●	

Crestwood's 5-Star Evolution Finish

2 Part Italian Polyurethane Coating

The single-component polyurethanes sold to DIY in consumer stores here in America are nothing like the Italian high-performance two-component polyurethanes sold to industrial wood manufacturers. The DIY polyurethanes are typically higher viscosity and formulated to be applied by brush or mop. Italian industrial wood polyurethanes are catalyzed, two-component (2K) systems in which the polyurethane resins chemically cross-link with each other to form very strong bonds. As such, 2K or catalyzed polyurethanes dry much faster and are more resistant to chemical and moisture attack than the DIY urethanes.

- **Superior mar, water, solvent and household chemical resistance**
- **Formaldehyde-free**
- **Low in HAP's and VOCs**
- **Meets or exceeds all KCMA performance standards**
- **More flexible to show less cracking from wood expansion and contraction**

Both formaldehyde, contained in most catalyzed finishes, and isocyanates, contained in 2K polyurethanes, are toxic substances. But formaldehyde is emitted from the finish for a considerable time after application, while isocyanates become totally reacted with the rest of the finish very quickly.

Crestwood is one of the only manufacturers in the United States to use 2-K polyurethane. Most manufacturers still use catalyzed finishes and though they have been working hard to reduce and even eliminate (in some cases) the formaldehyde in their catalyzed finishes, most of these finishes still contain some formaldehyde.



Two-part polyurethane is even more durable than conversion varnish. According to the Architectural Woodwork Institute, it is more wear, heat, solvent, moisture and stain resistant.

Walls

Simplicity
Face Frame

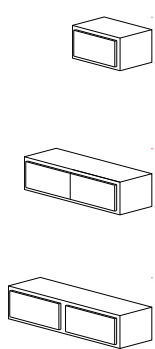
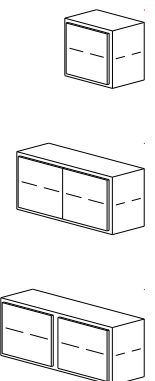
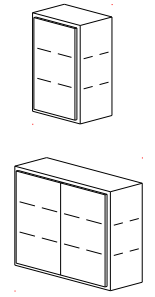

Walls

Cabinet depth is 12". First two figures of model number indicate width, second two are height, and special depth is specified after the height by a dash and the number of inches deep.		DRAWERS	DOORS	
	WALL 12", 15", 18" HIGH			
	No shelves. Specify hinge direction on single door cabinets. Cabinets 39" thru 48" wide have a 3" wide center stile.		1	W0912, 15, 18
			1	W1212, 15, 18
			1	W1512, 15, 18
			1	W1812, 15, 18
			1	W2112, 15, 18
			1	W2412, 15, 18
			2	W2712, 15, 18
			2	W3012, 15, 18
			2	W3312, 15, 18
		2	W3612, 15, 18	
		2	W3912, 15, 18	
		2	W4212, 15, 18	
		2	W4512, 15, 18	
		2	W4812, 15, 18	
	WALL 21", 24" HIGH			
	One adjustable shelf. Specify hinge direction on single door cabinets. Cabinets 39" thru 48" wide have a 3" wide center stile.		1	W0921, 24
			1	W1221, 24
			1	W1521, 24
			1	W1821, 24
			1	W2121, 24
			1	W2421, 24
			2	W2721, 24
			2	W3021, 24
			2	W3321, 24
		2	W3621, 24	
		2	W3921, 24	
		2	W4221, 24	
		2	W4521, 24	
		2	W4821, 24	
	WALL 30", 36" HIGH			
	Two adjustable shelves. Specify hinge direction on single door cabinets. Cabinets 39" thru 48" wide have a 3" wide center stile.		1	W0930, 36
			1	W1230, 36
			1	W1530, 36
			1	W1830, 36
			1	W2130, 36
			1	W2430, 36
			2	W2730, 36
			2	W3030, 36
			2	W3330, 36
		2	W3630, 36	
		2	W3930, 36	
		2	W4230, 36	
		2	W4530, 36	
		2	W4830, 36	

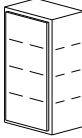
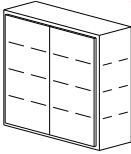
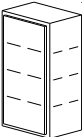
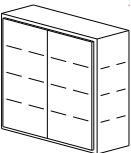
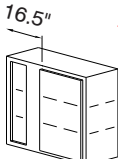
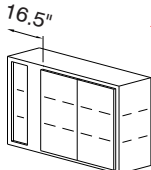
Cabinet depth is 12". First two figures of model number indicate width, second two are height, and special depth is specified after the height by a dash and the number of inches deep.		DRAWERS	DOORS	
 	WALL 42", 48" HIGH Three adjustable shelves. Specify hinge direction on single door cabinets. Cabinets 39" thru 48" wide have a 3" wide center stile.			
			1	W0942, 48
			1	W1242, 48
			1	W1542, 48
			1	W1842, 48
			1	W2142, 48
			1	W2442, 48
			2	W2742, 48
			2	W3042, 48
			2	W3342, 48
		2	W3642, 48	
		2	W3942, 48	
		2	W4242, 48	
		2	W4542, 48	
		2	W4842, 48	
 	WALL 60" HIGH Four adjustable shelves. Specify hinge direction on single door cabinets. Cabinets 39" thru 48" wide have a 3" wide center stile.			
			1	W0960
			1	W1260
			1	W1560
			1	W1860
			1	W2160
			1	W2460
			2	W2760
			2	W3060
			2	W3360
		2	W3660	
		2	W3960	
		2	W4260	
		2	W4560	
		2	W4860	
  <p>LEFT HAND BLIND SHOWN</p>	WALL BLIND CORNER 30", 36", 42", 48", 60" HIGH Two adjustable shelves for 30" and 36" high cabinets. Three adjustable shelves for 42" and 48". Four adjustable shelves for 60" high cabinets. Specify hinge direction on single door cabinets. Standard hinging is on blind side. Indicate blind left or right. Cabinets have a wide intermediate stile and can be pulled up to 3" from the corner. The adjacent cabinet must have a minimum 3" extended stile toward the blind corner. Cabinets 39" thru 48" have two doors with no center stile.			
			1	WBC-LT2430, 36, 42, 48, 60
			1	WBC-LT2730, 36, 42, 48, 60
			1	WBC-LT3030, 36, 42, 48, 60
			1	WBC-LT3330, 36, 42, 48, 60
			1	WBC-LT3630, 36, 42, 48, 60
			2	WBC-LT3930, 36, 42, 48, 60
			2	WBC-LT4230, 36, 42, 48, 60
			2	WBC-LT4530, 36, 42, 48, 60
			2	WBC-LT4830, 36, 42, 48, 60
			1	WBC-LT2430, 36, 42, 48, 60
			1	WBC-LT2730, 36, 42, 48, 60
			1	WBC-LT3030, 36, 42, 48, 60
			1	WBC-LT3330, 36, 42, 48, 60
			1	WBC-LT3630, 36, 42, 48, 60
			2	WBC-LT3930, 36, 42, 48, 60
		2	WBC-LT4230, 36, 42, 48, 60	
		2	WBC-LT4530, 36, 42, 48, 60	
		2	WBC-LT4830, 36, 42, 48, 60	
	MODIFICATIONS: FLUSH BLIND: Specify for flush blind when cabinet perpendicular to blind is shorter in height. NOTE: for Inset Cabinet Door, blind width is 13.5". width is actual cabinet box size.			
				FLUSH BLIND

Walls





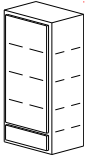
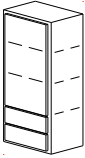

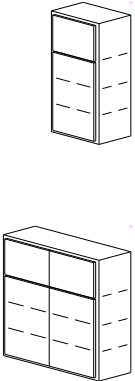
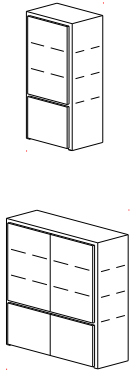
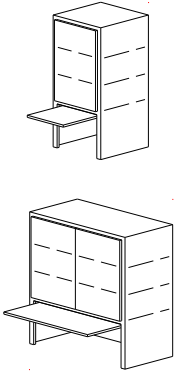
Simplicity
Face Frame

Walls

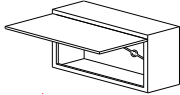
Cabinet depth is 12". First two figures of model number indicate width, second two are height, and special depth is specified after the height by a dash and the number of inches deep.		DRAWERS	DOORS	
	WALL MEDICINE CABINET 25" HIGH, 4.25" DEEP			
	Three adjustable shelves. Specify hinge direction. Cabinet has built-in face frame and eliminates the need for trim around wall opening. The face frame has an edge design compatible with the door edge profile. Rough opening should be 14" wide by 24.25" high. Cabinet will install between 2 x 4" studs at 16" on center.		1	WMC1625
	WALL DRAWER 48" HIGH			
	Specify hinge direction on single door cabinet. Cabinet not available less than 12"d.	1	1	WD1248, 60
		1	1	WD1548, 60
		1	1	WD1848, 60
	48"h Cabinet: Door opening is 38.625"h and drawer opening is 4.875"h. Three adjustable shelves.	1	1	WD2148, 60
		1	1	WD2448, 60
		1	2	WD2748, 60
	60"h Cabinet: Door opening is 50.625"h and drawer opening is 4.875"h. Three adjustable shelves.	1	2	WD3048, 60
		1	2	WD3348, 60
		1	2	WD3648, 60
NOTE: Modify drawer opening height using modification – DWR OP HT (10%) Modify drawer height using modification – DWR HT (10%)				
	WALL DRAWER (2) 48", 60" HIGH			
	Specify hinge direction on single door cabinet. Cabinet not available less than 12"d.	2	1	WD(2)1248, 60
		2	1	WD(2)1548, 60
		2	1	WD(2)1848, 60
	48"h Cabinet: Door opening is 32.25"h and drawer openings are 4.875"h. Two adjustable shelves.	2	1	WD(2)2148, 60
		2	1	WD(2)2448, 60
		2	2	WD(2)2748, 60
	60"h Cabinet: Door opening is 44.25"h and drawer openings are 4.875"h. Three adjustable shelves.	2	2	WD(2)3048, 60
		2	2	WD(2)3348, 60
		2	2	WD(2)3648, 60
	NOTE: Modify drawer opening height using modification – DWR OP HT D1-D2 (10%) Modify drawer height using modification – DWR HT D1-D2(10%)			

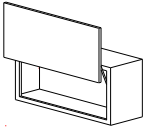
Cabinet depth is 12". First two figures of model number indicate width, second two are height, and special depth is specified after the height by a dash and the number of inches deep.		DRAWERS	DOORS	
	WALL COMBINATION 42", 54", 66" HIGH			
	Specify hinge direction on single door cabinets. Cabinets 39" thru 48" wide have a 3" wide center stile.		2	WCOM0942, 54, 66
	42" Cabinet: Two adjustable shelves in lower opening. Upper door opening is 10.5"h and lower door opening is 27"h.		2	WCOM1242, 54, 66
			2	WCOM1542, 54, 66
	54" Cabinet: Three adjustable shelves in lower opening. Upper door opening is 10.5"h and lower door opening is 39"h.		2	WCOM1842, 54, 66
			2	WCOM2142, 54, 66
			2	WCOM2442, 54, 66
	66" Cabinet: Three adjustable shelves in lower opening. Upper door opening is 10.5"h and lower door opening is 51"h.		4	WCOM2742, 54, 66
			4	WCOM3042, 54, 66
			4	WCOM3342, 54, 66
		4	WCOM3642, 54, 66	
		4	WCOM3942, 54, 66	
		4	WCOM4242, 54, 66	
		4	WCOM4542, 54, 66	
		4	WCOM4842, 54, 66	
	NOTE: Modify top opening height use modification – TOP OP HT (10%)			
	WALL MIXER STORAGE 48", 60", 72" HIGH			
	Specify hinge direction on single door cabinets. No bottom in lower opening.		2	WMS0948, 60, 72
			2	WMS1248, 60, 72
			2	WMS1548, 60, 72
	48" Cabinet: Two adjustable shelves in upper opening Upper door opening is 27"h and lower door opening is 17.25"h.		2	WMS1848, 60, 72
			2	WMS2148, 60, 72
	60" Cabinet: Three adjustable shelves in upper opening Upper door opening is 39"h and lower door opening is 17.25"h.		2	WMS2448, 60, 72
			4	WMS2748, 60, 72
			4	WMS3048, 60, 72
			4	WMS3348, 60, 72
72" Cabinet: Three adjustable shelves in upper opening Upper door opening is 51"h and lower door opening is 17.25"h.		4	WMS3648, 60, 72	
	NOTE: for Inset cabinet door, cabinet face frame center rail is 1.5" wide and lower door opening is 18" high.			
	NOTE: Modify bottom opening height using modification – BOT OP HT (10%)			
	WALL HORIZONTAL HIDE-AWAY 48", 60", 72" HIGH, 18" DEEP			
	Specify hinge direction on single door cabinets. No bottom in lower opening. Hide-away door is inset, wood grain on door insert runs horizontally.		2	WHHA1248, 60, 72
			2	WHHA1548, 60, 72
			2	WHHA1848, 60, 72
	48" Cabinet: Two adjustable shelves in upper opening Upper door opening is 27"h and lower door opening is 18"h.		2	WHHA2148, 60, 72
			2	WHHA2448, 60, 72
	60" Cabinet: Three adjustable shelves in upper opening Upper door opening is 39"h and lower door opening is 18"h.		3	WHHA2748, 60, 72
			3	WHHA3048, 60, 72
			3	WHHA3348, 60, 72
	72" Cabinet: Three adjustable shelves in upper opening Upper door opening is 51"h and lower door opening is 18"h.		3	WHHA3648, 60, 72
	NOTE: Modify bottom opening height using modification – BOT OP HT (10%)			

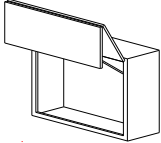
Walls

Cabinet depth is 12". First two figures of model number indicate width, second two are height, and special depth is specified after the height by a dash and the number of inches deep.		DRAWERS	DOORS		
	WALL LIFT DOOR 15", 18", 21", 24" HIGH, 12" DEEP				
	Wall Lift Door cabinets 24" thru 42" wide will be modified from two doors to one panel drawer front. Center stile is eliminated. Lift mechanism is supplied with BLUMOTION for soft and effortless opening and closing.		1	WLD 1515, 18, 21, 24	
			1	WLD 1815, 18, 21, 24	
			1	WLD 2115, 18, 21, 24	
			1	WLD 2415, 18, 21, 24	
			1	WLD 2715, 18, 21, 24	
			1	WLD 3015, 18, 21, 24	
			1	WLD 3315, 18, 21, 24	
			1	WLD 3615, 18, 21, 24	
			1	WLD 3915, 18, 21, 24	
			1	WLD 4215, 18, 21, 24	
			1	WLD 4515, 18, 21, 24	
		1	WLD 4815, 18, 21, 24		
	1	WLD 5415, 18, 21, 24			
	1	WLD 6015, 18, 21, 24			
	1	WLD 6615, 18, 21, 24			
	WALL LIFT SLIDE DOOR 15", 18", 21" HIGH, 12" DEEP				
	Wall Lift Slide Door cabinets 24" thru 42" wide will be modified from two doors to one panel drawer front. Center stile is eliminated. Lift slide mechanism is supplied with BLUMOTION for soft and effortless opening and closing.		1	WLSLD 1515, 18, 21	
			1	WLSLD 1815, 18, 21	
			1	WLSLD 2115, 18, 21	
			1	WLSLD 2415, 18, 21	
			1	WLSLD 2715, 18, 21	
			1	WLSLD 3015, 18, 21	
			1	WLSLD 3315, 18, 21	
			1	WLSLD 3615, 18, 21	
			1	WLSLD 3915, 18, 21	
			1	WLSLD 4215, 18, 21	
			1	WLSLD 4515, 18, 21	
			1	WLSLD 4815, 18, 21	
	1	WLSLD 5415, 18, 21			
	1	WLSLD 6015, 18, 21			
	1	WLSLD 6615, 18, 21			
	1	WLSLD 7215, 18, 21			
	WALL LIFT BIFOLD DOORS 24", 30", 36", 42" HIGH, 12" DEEP				
	Wall Lift Bifold Door cabinets 24" thru 42" wide will be modified from two doors to two panel drawer fronts. Center stile is eliminated. Lift bifold mechanism is supplied with BLUMOTION for soft and effortless opening and closing. Lift bifold can be left to hang at the desired height.		2	WLBFD 1524, 30, 36, 42	
			2	WLBFD 1824, 30, 36, 42	
			2	WLBFD 2124, 30, 36, 42	
			2	WLBFD 2424, 30, 36, 42	
			2	WLBFD 2724, 30, 36, 42	
			2	WLBFD 3024, 30, 36, 42	
			2	WLBFD 3324, 30, 36, 42	
			2	WLBFD 3624, 30, 36, 42	
			2	WLBFD 3924, 30, 36, 42	

Walls

Simplicity
Face Frame

Walls

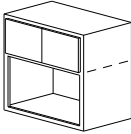
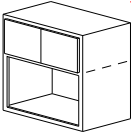
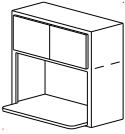
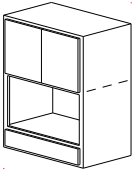
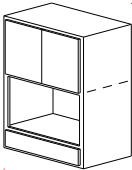
Cabinet depth is 12". First two figures of model number indicate width, second two are height, and special depth is specified after the height by a dash and the number of inches deep.		DRAWERS	DOORS	
	WALL MICROWAVE 30", 36", 42", 54", 66" HIGH, 18" DEEP			
	Door opening height varies due to cut-out size. Specify width and height of microwave cut-out. Maximum width of cut-out is 2" less than cabinet width. Cabinet 42 thru 66 high comes with one shelf.		1 2 2 2	WM2430, 36, 42, 54, 66-18 WM2730, 36, 42, 54, 66-18 WM3030, 36, 42, 54, 66-18 WM3330, 36, 42, 54, 66-18
	WALL MICROWAVE-OPEN SHELF 30", 36", 42", 54", 66" HIGH, 18" DEEP			
	Door opening height varies due to open shelf size. Open shelf area width is 3" less than cabinet width. Specify height of open shelf area. Cabinet interior has same wood and finish as exterior. Cabinet 42 thru 66 high comes with one shelf.		1 2 2 2	WM-OS2430, 36, 42, 54, 66-18 WM-OS2730, 36, 42, 54, 66-18 WM-OS3030, 36, 42, 54, 66-18 WM-OS3330, 36, 42, 54, 66-18
	WALL MICROWAVE-EXTENDED OPEN SHELF 30", 36", 42", 54", 66" HIGH, 12" DEEP			
	Door opening height varies due to open shelf size. Open shelf area width is 3" less than cabinet width. Specify height of open shelf area. Shelf depth is 18". Cabinet interior has same wood and finish as exterior. Cabinet 42 thru 66 high comes with one shelf.		1 2 2 2	WM-EOS2430, 36, 42, 54, 66 WM-EOS2730, 36, 42, 54, 66 WM-EOS3030, 36, 42, 54, 66 WM-EOS3330, 36, 42, 54, 66
	WALL MICROWAVE DRAWER 48", 60", 72" HIGH, 18" DEEP			
	Door opening height varies due to cut-out size. Drawer opening is 4.875" high. Specify width and height of microwave cut-out. Maximum width of cut-out is 2" less than cabinet width. Cabinet 60" and 72" high comes with one shelf. NOTE: Modify drawer opening height using modification – DWR OP HT (10%) Modify drawer height using modification – DWR HT (10%)	1 1 1 1	1 2 2 2	WMD2448, 60, 72-18 WMD2748, 60, 72-18 WMD3048, 60, 72-18 WMD3348, 60, 72-18
	WALL MICROWAVE DRAWER-OPEN SHELF 48", 60", 72" HIGH, 18" DEEP			
	Door opening height varies due to open shelf size. Drawer opening is 4.875" high. Specify height of open shelf area. Open shelf area width is 3" less than cabinet width. Cabinet interior has same wood and finish as exterior. Cabinet 60" and 72" high comes with one shelf. NOTE: Modify drawer opening height using modification – DWR OP HT (10%) Modify drawer height using modification – DWR HT (10%)	1 1 1 1	1 2 2 2	WMD-OS2448, 60, 72-18 WMD-OS2748, 60, 72-18 WMD-OS3048, 60, 72-18 WMD-OS3348, 60, 72-18

Walls

Walls

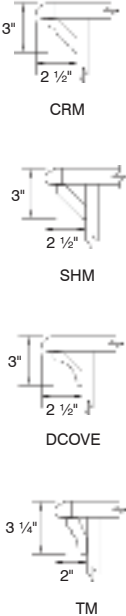
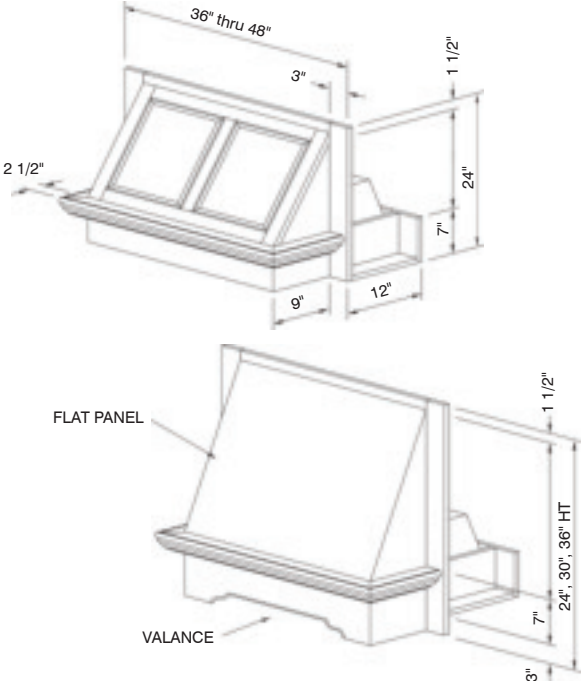

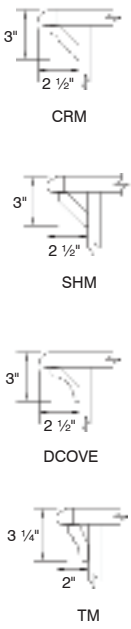
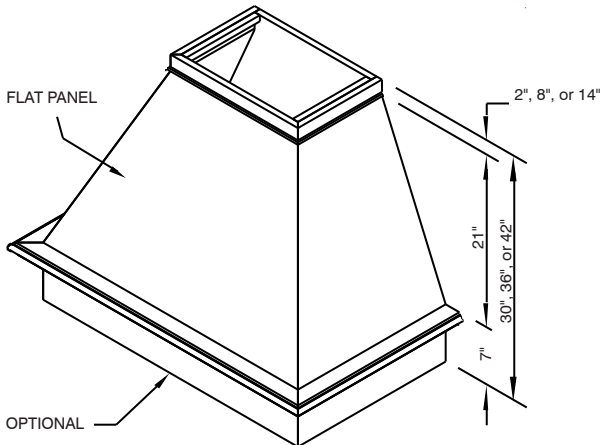

<p>Cabinet depth is 12". First two figures of model number indicate width, second two are height, and special depth is specified after the height by a dash and the number of inches deep.</p>	DRAWERS	DOORS	
	<p>WALL HOOD FRONT 24", 30", 36" HIGH</p> <p>Wall Hood Front is standard with a white enamel steel liner and blower ventilation system by VentAHood.</p> <p>Ventilation system includes halogen lights, switches, and Sensa-Source S/S-1 (speed control system). Single Blower outlet is 6" round.</p> <p>WHF must be mounted between two 12" deep wall cabinets.</p> <p>The decorative panel fronts will be the same as specified for cabinet door style with some exceptions.</p> <p>For efficiency, it is recommended that the WHF be installed 27" to 30" from the cooking surface. It is also recommended the WHF be at least 6" wider than the cooktop.</p> <p>Blower Specs: Single Blower w/2 Lts - 300 CFM - 115V, 2.7A, 60Hz, 1550 RPM</p> <p>Available Modifications: Dual Blower is available by specifying DUAL Flat Panel Front is available by specifying FLAT Valance Option is available by specifying VAL (style) Molding Option is available by specifying MLD and molding type(CRM, SHM, DCOVE, TM)</p> <p>Note: WHF 24" high only available with Valance C.</p> <p>Caution: Range Hoods are subject to local building codes. Please check your local building codes before placing an order. Due to variations in local building codes, it is your responsibility to meet these code requirements.</p> 		<p>WHF3624, 30, 36 WHF4224, 30, 36 WHF4824, 30, 36</p> <p>DUAL FLAT VAL(style) MLD(type)</p>

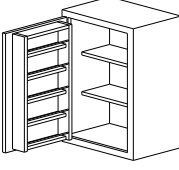

Cabinet depth is 12". First two figures of model number indicate width, second two are height, and special depth is specified after the height by a dash and the number of inches deep.	DRAWERS	DOORS		
	<p>WALL FLARED HOOD 30", 36", 42", 54" HIGH, 21" or 24" DEEP</p> <p>Wall Flared Hood is standard with a stainless steel liner and blower ventilation system by VentAHood.</p> <p>Ventilation system includes halogen lights, switches, and Sensa-Source S/S-1 (speed control system). Single Blower outlet is 6" round. Dual Blower outlet is 8" round. Optional transitions are available for combination blowers.</p> <p>For efficiency, it is recommended that the WFLH be installed 27" to 30" from the cooking surface. It is also recommended the WFLH be at least 6" wider than the cooktop.</p> <p>Blower Specs: 36" thru 42" wide Dual Blower w/2 Lts - 600 CFM - 115V, 4.4A, 60Hz, 1550 RPM</p> <p>48" wide Dual/Single Blower w/3 Lts - 900CFM - 115V,6.6A,60Hz,1550RPM</p> <p>54" thru 66" wide (2)Dual Blower w/3 Lts - 1200 CFM - 115V, 8.3A, 60Hz, 1550 RPM</p> <p>Available Modifications: Valance Option is available by specifying VAL (style) Molding Option is available by specifying MLD and molding type(CRM, SHM, DCOVE, TM) Optional Support Block and Wood Support Bracket may be ordered by specifying SBL(style). SBL reduces ventilation system by 6".</p> <p>Caution: Range Hoods are subject to local building codes. Please check your local building codes before placing an order. Due to variations in local building codes, it is your responsibility to meet these code requirements.</p> 			<p>WFLH3630, 36, 42, 54 - 21 WFLH4230, 36, 42, 54 - 21 WFLH3630, 36, 42, 54 - 24 WFLH4230, 36, 42, 54 - 24 WFLH4830, 36, 42, 54 - 24 WFLH5430, 36, 42, 54 - 24 WFLH6030, 36, 42, 54 - 24 WFLH6630, 36, 42, 54 - 24</p> <p>VAL(style) MLD(type) SBL(type)</p>

Walls

Simplicity
Face Frame

Walls

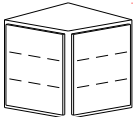
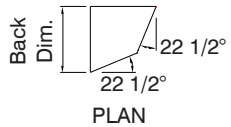
Cabinet depth is 12". First two figures of model number indicate width, second two are height, and special depth is specified after the height by a dash and the number of inches deep.		DRAWERS	DOORS	
	WALL DOOR SPICE RACK (WOOD) 30" HIGH			
	Specify hinge direction. DSR(WD) is 12" w x 28" h x 3" d and has five fixed shelves. Natural maple wood finish. Attached to door.		1	W(DSR-WD)1530
	WALL DOOR SPICE RACK (FROSTED NICKEL CHROME) 30" HIGH			
	Specify hinge direction. DSR(CH) has four fixed shelves with bottom shelf 1" deeper for larger items and is attached to the door. Overall size is 10 13/16" or 13 13/16" w x 20"h x 3 7/8"d		1 1	W(DSR-CHR)1530 W(DSR-CHR)1830
	WALL PULL-OUT PANTRY-CHROME 30" HIGH			
	Fits in standard 9" or 12" wide x 30" high wall cabinet and a minimum cabinet depth of 12". Four tier pull-out pantry with chrome fence rail, three are adjustable. Attached to door.		1 1	W(PP-CHR)0930 W(PP-CHR)1230
	WALL ABOVE APPLIANCE PULL-OUT 18", 24" HIGH - 24" DEEP			
	Fits in standard 33" or 36" wide x 18" high wall cabinet and a minimum cabinet depth of 24". Chrome, door mounted pull-out rack.		2 2 2 2	W(AAP-CHR)3318-24 W(AAP-CHR)3618-24 W(AAP-CHR)3324-24 W(AAP-CHR)3624-24

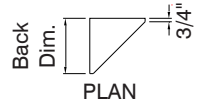

Cabinet depth is 12". First two figures of model number indicate width, second two are height, and special depth is specified after the height by a dash and the number of inches deep.		DRAWERS	DOORS													
  <p>Back Dim. 22 1/2° PLAN</p>	<p>WALL ANGLE CORNER 30", 36", 42", 48", 60" HIGH</p> <p>Two adjustable shelves for 30" and 36" high cabinets. Three adjustable shelves for 42" and 48" high cabinets. Four adjustable shelves for 60" high cabinet. Not available with finished end panels.</p> <table border="0"> <tr> <td>Cabinet Back Dimension</td> <td>Cabinet Door Opening Width</td> </tr> <tr> <td>12" x 12"</td> <td>5 13/16"</td> </tr> <tr> <td>15" x 15"</td> <td>8 1/8"</td> </tr> <tr> <td>18" x 18"</td> <td>10 3/8"</td> </tr> <tr> <td>21" x 21"</td> <td>12 11/16"</td> </tr> <tr> <td>24" x 24"</td> <td>15"</td> </tr> </table> <p>*CAUTION: Due to small door width, check on minimum size requirements on door styles. Raised Panel Door Styles will have a flat insert and Presidential, Wellington, and Cedar Crest Door Styles will be one piece solid wood.</p>	Cabinet Back Dimension	Cabinet Door Opening Width	12" x 12"	5 13/16"	15" x 15"	8 1/8"	18" x 18"	10 3/8"	21" x 21"	12 11/16"	24" x 24"	15"			
	Cabinet Back Dimension	Cabinet Door Opening Width														
12" x 12"	5 13/16"															
15" x 15"	8 1/8"															
18" x 18"	10 3/8"															
21" x 21"	12 11/16"															
24" x 24"	15"															
			2 2 2 2 2	WAC1230, 36, 42, 48, 60 WAC1530, 36, 42, 48, 60 WAC1830, 36, 42, 48, 60 WAC2130, 36, 42, 48, 60 WAC2430, 36, 42, 48, 60												
  <p>Back Dim. 3/4" PLAN</p>	<p>WALL CORNER 32", 36", 42", 48", 60" HIGH</p> <p>Two adjustable shelves for 30" and 36" high cabinets. Three adjustable shelves for 42" and 48" high cabinets. Four adjustable shelves for 60" high cabinets. Not available with finished end panels.</p> <table border="0"> <tr> <td>Cabinet Back Dimension</td> <td>Cabinet Door Opening Width</td> </tr> <tr> <td>12" x 12"</td> <td>12 3/8"</td> </tr> <tr> <td>15" x 15"</td> <td>16 5/8"</td> </tr> <tr> <td>18" x 18"</td> <td>20 7/8"</td> </tr> <tr> <td>21" x 21"</td> <td>25 1/8"</td> </tr> <tr> <td>24" x 24"</td> <td>29 3/8"</td> </tr> </table> <p>Specify hinge direction on single door cabinet.</p>	Cabinet Back Dimension	Cabinet Door Opening Width	12" x 12"	12 3/8"	15" x 15"	16 5/8"	18" x 18"	20 7/8"	21" x 21"	25 1/8"	24" x 24"	29 3/8"			
	Cabinet Back Dimension	Cabinet Door Opening Width														
12" x 12"	12 3/8"															
15" x 15"	16 5/8"															
18" x 18"	20 7/8"															
21" x 21"	25 1/8"															
24" x 24"	29 3/8"															
			1 1 1 2 2	WC1230, 36, 42, 48, 60 WC1530, 36, 42, 48, 60 WC1830, 36, 42, 48, 60 WC2130, 36, 42, 48, 60 WC2430, 36, 42, 48, 60												

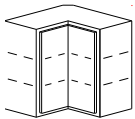
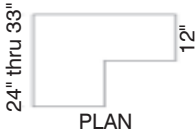
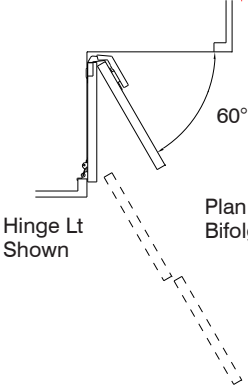
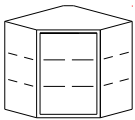
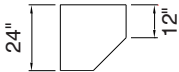
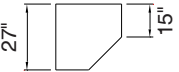
Walls

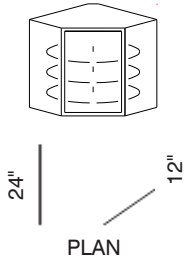
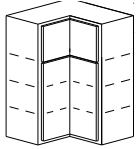
Cabinet depth is 12". First two figures of model number indicate width, second two are height, and special depth is specified after the height by a dash and the number of inches deep.		DRAWERS	DOORS	
  PLAN	WALL SQUARE CORNER 30", 36", 42", 48", 60" HIGH			
	Cabinet back dimension is 24" x 24" thru 33" x 33". Doors open 170°. Doors are hinged together making a bifold. Specify hinge direction.		2	WSC2430, 36, 42, 48, 60
	30", 36"h Cabinet: Two adjustable shelves		2	WSC2730, 36, 42, 48, 60
	42", 48"h Cabinet: Three adjustable shelves		2	WSC3030, 36, 42, 48, 60
	60"h Cabinet: Four adjustable shelves		2	WSC3330, 36, 42, 48, 60
  PLAN	WALL DIAGONAL CORNER 30", 36", 42", 48" HIGH			
	Cabinet back dimension is 24" x 24" or 27" x 27". Door opening width is 13.5". Specify hinge direction.		1	WDC2430
	30", 36"h Cabinet: Two adjustable shelves		1	WDC2436
	42", 48"h Cabinet: Three adjustable shelves		1	WDC2442
	60"h Cabinet: Four adjustable shelves		1	WDC2448
 PLAN				
			1	WDC2460
			1	WDC2730-15
			1	WDC2736-15
			1	WDC2742-15
		1	WDC2748-15	
		1	WDC2760-15	

Cabinet depth is 12". First two figures of model number indicate width, second two are height, and special depth is specified after the height by a dash and the number of inches deep.		DRAWERS	DOORS	
	<p>WALL DIAGONAL CORNER WOOD LAZY SUSAN 30", 36", 42", 48", 60" HIGH</p>			
	<p>Cabinet back dimension is 24" x 24" or 27" x 27". Door opening width is 13.5". Specify hinge direction.</p>		1	WDCWL2430
	<p>30", 36"h Cabinet: Three revolving, 18" diameter, wood shelves in upper opening.</p>		1	WDCWL2436
			1	WDCWL2442
			1	WDCWL2448
			1	WDCWL2460
	<p>42", 48", 60"h Cabinet: Four revolving, 18" diameter, wood shelves in upper opening.</p>		1	WDCWL2730-15
		1	WDCWL2736-15	
		1	WDCWL2742-15	
		1	WDCWL2748-15	
		1	WDCWL2760-15	
	<p>WALL SQUARE CORNER COMBINATION 42", 54", 66" HIGH</p>			
	<p>Cabinet back dimension is 24" x 24". Doors open 170°.</p>		4	WSC-COM2442
	<p>Doors are hinged together making a bifold. Specify hinge direction.</p>		4	WSC-COM2454
			4	WSC-COM2466
	<p>42"h Cabinet: Two adjustable shelves in lower opening. Upper door opening is 10.5"h and lower door opening is 27"h.</p>			
	<p>54"h Cabinet: Three adjustable shelves in lower opening. Upper door opening is 10.5"h and lower door opening is 39"h.</p>			
	<p>66"h Cabinet: Three adjustable shelves in lower opening. Upper door opening is 10.5"h and lower door opening is 51"h.</p>			
	<p>NOTE: Modify top opening height using modification – TOP OP HT (10%)</p>			

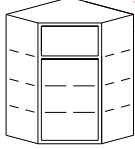
Walls

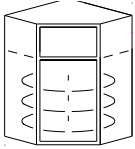

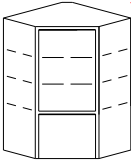
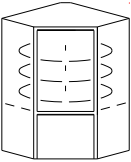



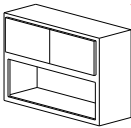
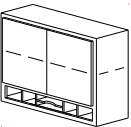

Cabinet depth is 12". First two figures of model number indicate width, second two are height, and special depth is specified after the height by a dash and the number of inches deep.		DRAWERS	DOORS	
  PLAN  PLAN	WALL DIAGONAL CORNER COMBINATION 42", 54", 66" HIGH			
	Cabinet back dimension is 24" x 24" or 27" x 27". Door opening width is 13.5". Specify hinge direction.		2	WDC-COM2442
	42"h Cabinet: Two adjustable shelves in lower opening. Upper door opening is 10.5"h and lower door opening is 27"h.		2	WDC-COM2454
			2	WDC-COM2466
	54"h Cabinet: Three adjustable shelves in lower opening. Upper door opening is 10.5"h and lower door opening is 39"h.		2	WDC-COM2742-15
			2	WDC-COM2754-15
			2	WDC-COM2766-15
	66"h Cabinet: Three adjustable shelves in lower opening. Upper door opening is 10.5"h and lower door opening is 51"h.			
	NOTE: Modify top opening height using modification – TOP OP HT (10%)			
	WALL DIAGONAL CORNER WOOD LAZY SUSAN COMBINATION 42", 54", 66" HIGH			
	Cabinet back dimension is 24" x 24" or 27" x 27". Door opening width is 13.5". Specify hinge direction.		2	WDCWL-COM2442
			2	WDCWL-COM2454
			2	WDCWL-COM2466
	42"h Cabinet: Three revolving, 18" diameter, wood shelves in upper opening. Upper door opening is 10.5"h and lower door opening is 27"h.		2	WDCWL-COM2742-15
			2	WDCWL-COM2754-15
			2	WDCWL-COM2766-15
	54"h Cabinet: Four revolving, 18" diameter, wood shelves in upper opening. Upper door opening is 10.5"h and lower door opening is 27"h.			
	66"h Cabinet: Four revolving, 18" diameter, wood shelves in upper opening. Upper door opening is 10.5"h and lower door opening is 27"h.			
	NOTE: Modify top opening height using modification – TOP OP HT (10%)			

Cabinet depth is 12". First two figures of model number indicate width, second two are height, and special depth is specified after the height by a dash and the number of inches deep.		DRAWERS	DOORS	
	WALL DIAGONAL CORNER-MIXER STORAGE 48", 60", 72" HIGH			
	Cabinet back dimension is 24" x 24" or 27" x 27". Door opening width is 13.5". Specify hinge direction.		2	WDC-MS2448
	48"h Cabinet: Two adjustable shelves in upper opening Upper door opening is 27"h and lower door opening is 17.25"h.		2	WDC-MS2460
			2	WDC-MS2472
	60"h Cabinet: Three adjustable shelves in upper opening Upper door opening is 39"h and lower door opening is 17.25"h.		2	WDC-MS2748-15
			2	WDC-MS2760-15
			2	WDC-MS2772-15
72"h Cabinet: Three adjustable shelves in upper opening Upper door opening is 51"h and lower door opening is 17.25"h.				
For Inset, Concealed Half Overlay and Knife Hinge cabinet door, cabinet face frame center rail is 1.5" wide and lower door opening is 18" high.				
NOTE: Modify bottom opening height using modification – BOT OP HT (10%)				
	WALL DIAGONAL CORNER LAZY SUSAN MIXER STORAGE 48", 60", 72" HIGH			
	Cabinet back dimension is 24" x 24" or 27" x 27". Door opening width is 13.5". Specify hinge direction.		2	WDCWL-MS2448
	48"h Cabinet: Three revolving, 18" diameter, wood shelves in upper opening. Upper door opening is 27"h and lower door opening is 17.25"h.		2	WDCWL-MS2460
			2	WDCWL-MS2472
	60"h Cabinet: Four revolving, 18" diameter, wood shelves in upper opening. Upper door opening is 27"h and lower door opening is 17.25"h.		2	WDCWL-MS2748-15
			2	WDCWL-MS2760-15
			2	WDCWL-MS2772-15
72"h Cabinet: Four revolving, 18" diameter, wood shelves in upper opening. Upper door opening is 27"h and lower door opening is 17.25"h.				
For Inset, Concealed Half Overlay and Knife Hinge cabinet door, cabinet face frame center rail is 1.5" wide and lower door opening is 18" high.				
NOTE: Modify bottom opening height using modification – BOT OP HT (10%)				

Walls

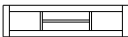

Simplicity
Face Frame

Walls

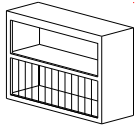
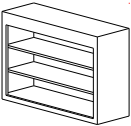
Cabinet depth is 12". First two figures of model number indicate width, second two are height, and special depth is specified after the height by a dash and the number of inches deep.		DRAWERS	DOORS	
	WALL BOTTOM OPEN 30", 36", 42", 48", 54", 66" HIGH			
	Cabinet interior has same finish as exterior. Cabinets 39" thru 48" wide have a 3" wide center stile. 30"h Cabinet: Door height is 12", no shelves		1	WBO24x30, 36, 42, 48, 54, 66
			2	WBO27x30, 36, 42, 48, 54, 66
			2	WBO30x30, 36, 42, 48, 54, 66
			2	WBO33x30, 36, 42, 48, 54, 66
			2	WBO36x30, 36, 42, 48, 54, 66
			2	WBO39x30, 36, 42, 48, 54, 66
			2	WBO42x30, 36, 42, 48, 54, 66
			2	WBO45x30, 36, 42, 48, 54, 66
			2	WBO48x30, 36, 42, 48, 54, 66
	36"h Cabinet: Door height is 18", no shelves			
	42"h Cabinet: Door height is 24", 1 shelf			
	48"h Cabinet: Door height is 30", 2 shelves			
	54"h Cabinet: Door height is 36", 2 shelves			
	66"h Cabinet: Door height is 42", 3 shelves NOTE: Modify open shelf height using modification – OS HT (10%)			
	WALL PIGEONHOLE 30", 36", 42", 48", 54", 66" HIGH			
	Cabinet interior has same finish as exterior. Bottom opening height is 4.5". Cabinets 39" thru 48" wide have a 3" wide center stile.		1	WP24x30, 36, 42, 48, 54, 66
			2	WP27x30, 36, 42, 48, 54, 66
			2	WP30x30, 36, 42, 48, 54, 66
			2	WP33x30, 36, 42, 48, 54, 66
			2	WP36x30, 36, 42, 48, 54, 66
			2	WP39x30, 36, 42, 48, 54, 66
			2	WP42x30, 36, 42, 48, 54, 66
			2	WP45x30, 36, 42, 48, 54, 66
			2	WP48x30, 36, 42, 48, 54, 66
		30"h Cabinet: Door height is 23", 1 shelf		
		36"h Cabinet: Door height is 29", 2 shelves		
		42"h Cabinet: Door height is 35", 2 shelves		
		48"h Cabinet: Door height is 41", 3 shelves		
		54"h Cabinet: Door height is 47", 3 shelves		
		66"h Cabinet: Door height is 53", 4 shelves		
		Partition Plans - Center area will accommodate 8 1/2" x 11" paper:		
	 24" wide			
	 33" wide			
	 42" wide			
	 27" wide			
	 36" wide			
	 45" wide			
	 30" wide			
	 39" wide			
	 48" wide			

Cabinet depth is 12". First two figures of model number indicate width, second two are height, and special depth is specified after the height by a dash and the number of inches deep.		DRAWERS	DOORS												
	WALL WITH PLATE RACK 30", 36", 42", 48", 54", 66" HIGH														
	Cabinet interior has same finish as exterior. Plate rack opening height is 12". Wood plate rack dowels are spaced 2 1/2" on center.		1	WPR24x30, 36, 42, 48, 54, 66											
	30"h Cabinet: Door height is 15.5", no shelves		2	WPR27x30, 36, 42, 48, 54, 66											
	36"h Cabinet: Door height is 21.5", 1 shelf		2	WPR30x30, 36, 42, 48, 54, 66											
	42"h Cabinet: Door height is 27.5", 2 shelves		2	WPR33x30, 36, 42, 48, 54, 66											
	48"h Cabinet: Door height is 33.5", 2 shelves		2	WPR36x30, 36, 42, 48, 54, 66											
	54"h Cabinet: Door height is 39.5", 3 shelves														
	66"h Cabinet: Door height is 45.5", 3 shelves														
	NOTE: Modify open shelf height using modification – OS HT (10%)														
	<table border="1"> <thead> <tr> <th>Cabinet Width</th> <th>Plate Capacity</th> </tr> </thead> <tbody> <tr> <td>24"</td> <td>9</td> </tr> <tr> <td>27"</td> <td>10</td> </tr> <tr> <td>30"</td> <td>11</td> </tr> <tr> <td>33"</td> <td>13</td> </tr> <tr> <td>36"</td> <td>14</td> </tr> </tbody> </table>	Cabinet Width	Plate Capacity	24"	9	27"	10	30"	11	33"	13	36"	14		
Cabinet Width	Plate Capacity														
24"	9														
27"	10														
30"	11														
33"	13														
36"	14														
	WALL BOOKCASE 30", 36", 42", 48", 60" HIGH														
	Cabinet interior has same finish as exterior.			WB12x30, 36, 42, 48, 60											
	30"h cabinet: Two shelves			WB15x30, 36, 42, 48, 60 WB18x30, 36, 42, 48, 60											
	36"h Cabinet: Two shelves			WB21x30, 36, 42, 48, 60 WB24x30, 36, 42, 48, 60 WB27x30, 36, 42, 48, 60											
	42"h Cabinet: Three shelves			WB30x30, 36, 42, 48, 60 WB33x30, 36, 42, 48, 60 WB36x30, 36, 42, 48, 60											
	48"h Cabinet: Three shelves			VAL (Style) HS-SWM											
	60"h Cabinet: Four shelves														
	MODIFICATIONS: VAL (Style): Cabinet standard with straight valance C. Optional valance styles are available.														
	HS-SWM: Shelves with edge mold are available and recommended on wide cabinets.														

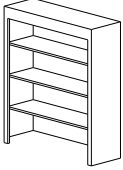
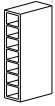
Walls

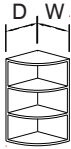
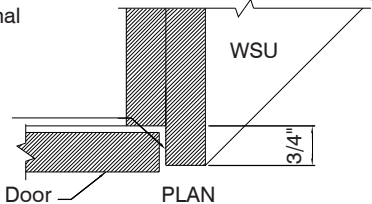
Cabinet depth is 12". First two figures of model number indicate width, second two are height, and special depth is specified after the height by a dash and the number of inches deep.		DRAWERS	DOORS																	
	WALL COUNTERTOP BOOKCASE 54", 66", 84" HIGH																			
	Cabinet interior has same finish as exterior. Bottom shelf is fixed with mechanical fasteners for structural support. Shelf can be relocated if necessary.			WCB12x54, 66, 84 WCB15x54, 66, 84 WCB18x54, 66, 84 WCB21x54, 66, 84 WCB24x54, 66, 84 WCB27x54, 66, 84 WCB30x54, 66, 84 WCB33x54, 66, 84 WCB36x54, 66, 84																
	54"h Cabinet: Three shelves 66"h Cabinet: Four shelves 84"h Cabinet: Five Shelves																			
	MODIFICATIONS: VAL (Style): Cabinet standard with straight valance C. Optional valance styles are available. HS-SWM: Shelves with edge mold are available and recommended on wide cabinets.			VAL (Style) HS-SWM																
				NO VAL																
	WALL WINE RACK 6" WIDE, 12" DEEP																			
	Interior has same finish as exterior. Wine rack shelving is fixed. 30" high = 6 openings 36" high = 8 openings 42" high = 9 openings 48" high = 10 openings			WWR0630 WWR0636 WWR0642 WWR0648																
 WPWR	WALL PARTITION WINE RACK 12" DEEP (Wood Only)																			
	Interior has same finish as exterior. Wine rack has 3/4" partitions at 45° angle.			WPWR1515 WPWR1818 WPWR2121																
 WSU-RT 12x30-12 Radius	WALL SHELF UNIT																			
	All fixed shelving. Interior has same finish as exterior. Specify width, height and depth. Specify if unit is LT or RT. Specify radius or diagonal.			WSU-LT W x H - D WSU-RT W x H - D																
	<table border="0"> <tr> <td>Unit Height</td> <td>No. of shelves</td> <td></td> </tr> <tr> <td>18" to 27"</td> <td>One</td> <td></td> </tr> <tr> <td>to 39"</td> <td>Two</td> <td></td> </tr> <tr> <td>to 54"</td> <td>Three</td> <td rowspan="3">Number of shelves does not include top and bottom.</td> </tr> <tr> <td>to 69"</td> <td>Four</td> </tr> <tr> <td>to 84"</td> <td>Five</td> </tr> </table>	Unit Height	No. of shelves		18" to 27"	One		to 39"	Two		to 54"	Three	Number of shelves does not include top and bottom.	to 69"	Four	to 84"	Five			
	Unit Height	No. of shelves																		
	18" to 27"	One																		
to 39"	Two																			
to 54"	Three	Number of shelves does not include top and bottom.																		
to 69"	Four																			
to 84"	Five																			
Specify 3/4" additional depth if WSU is to be flush with cabinet doors. No additional charge.																				
Exposed back edge is finished when specifying for the 3/4" additional depth.																				



Simplicity
Face Frame

Bases

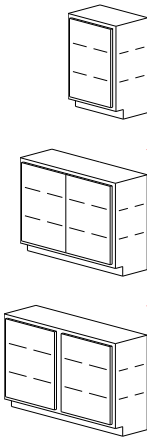
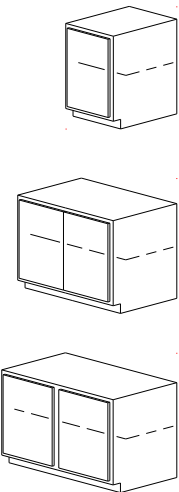
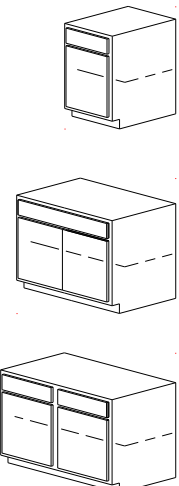

Bases

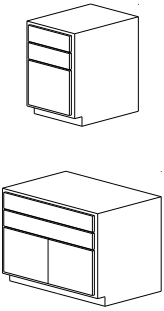
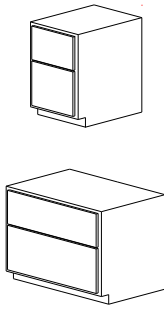
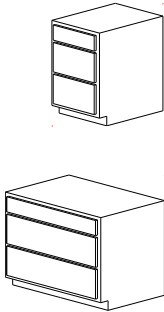
Cabinets are 34.5" high by 24" deep unless specified. Model number indicates width. Special height is shown by stating number of inches after width. Special depth is specified after width or height by a dash and the number of inches deep.		DRAWERS	DOORS	
	BASE FULL DOOR 34.5", 40.5", 60" HIGH - 12" DEEP			
	Specify hinge direction on single door cabinet. Cabinets 39" thru 48" wide have a 3" wide center stile. 34.5" high cabinet, two adjustable shelves. 40.5" high cabinet, three adjustable shelves. 60" high cabinet, four adjustable shelves. Full depth shelf included.		1	BFD09x34.5, 40.5, 60 -12
			1	BFD12x34.5, 40.5, 60 -12
			1	BFD15x34.5, 40.5, 60 -12
			1	BFD18x34.5, 40.5, 60 -12
			1	BFD21x34.5, 40.5, 60 -12
			1	BFD24x34.5, 40.5, 60 -12
			2	BFD27x34.5, 40.5, 60 -12
			2	BFD30x34.5, 40.5, 60 -12
			2	BFD33x34.5, 40.5, 60 -12
	BASE FULL DOOR 34.5", 40.5", 60" HIGH			
	Specify hinge direction on single door cabinet. Cabinets 39" thru 48" wide have a 3" wide center stile. 34.5" high cabinet, one adjustable shelf, 18.5" deep. 40.5" high cabinet, two adjustable shelves, 18.5" deep. 60" high cabinet, three adjustable shelves, 18.5" deep. 3/4 depth shelf standard.		1	BFD09x34.5, 40.5, 60
			1	BFD12x34.5, 40.5, 60
			1	BFD15x34.5, 40.5, 60
			1	BFD18x34.5, 40.5, 60
			1	BFD21x34.5, 40.5, 60
			1	BFD24x34.5, 40.5, 60
			2	BFD27x34.5, 40.5, 60
			2	BFD30x34.5, 40.5, 60
			2	BFD33x34.5, 40.5, 60
	BASE 34.5", 40.5", 60" HIGH			
	Specify hinge direction on single door cabinet. Cabinets 39" thru 48" wide have a 3" wide center stile. Cabinets 39" thru 48" wide have two drawers. 34.5" high cabinet, one adjustable shelf, 18.5" deep. 40.5" high cabinet, two adjustable shelves, 18.5" deep. 60" high cabinet, three adjustable shelves, 18.5" deep. NOTE: Modify drawer opening height using modification – DWR OP HT (10%) Modify drawer height using modification – DWR HT (10%)	1	1	B09x34.5, 40.5, 60
		1	1	B12x34.5, 40.5, 60
		1	1	B15x34.5, 40.5, 60
		1	1	B18x34.5, 40.5, 60
		1	1	B21x34.5, 40.5, 60
		1	1	B24x34.5, 40.5, 60
		1	2	B27x34.5, 40.5, 60
		1	2	B30x34.5, 40.5, 60
		1	2	B33x34.5, 40.5, 60
	1	2	B36x34.5, 40.5, 60	
	2	2	B39x34.5, 40.5, 60	
	2	2	B42x34.5, 40.5, 60	
	2	2	B45x34.5, 40.5, 60	
	2	2	B48x34.5, 40.5, 60	

Cabinets are 34.5" high by 24" deep unless specified. Model number indicates width. Special height is shown by stating number of inches after width. Special depth is specified after width or height by a dash and the number of inches deep.		DRAWERS	DOORS	
	BASE DOUBLE DRAWER 34.5", 40.5", 60" HIGH			
	Specify hinge direction on single door cabinet.	2	1	BDD09x34.5, 40.5, 60
	34.5" High Cabinet: No shelves. Two small drawer opening heights are 4.875" and door opening height is 14.25".	2	1	BDD12x34.5, 40.5, 60
		2	1	BDD15x34.5, 40.5, 60
		2	1	BDD18x34.5, 40.5, 60
	40.5" High Cabinet: One adjustable shelf, 18" deep. Two small drawer opening heights are 4.875" and door opening height is 20.25".	2	1	BDD21x34.5, 40.5, 60
		2	1	BDD24x34.5, 40.5, 60
		2	2	BDD27x34.5, 40.5, 60
	60" High Cabinet: Three adjustable shelves, 18" deep. Two small drawer opening heights are 4.875" and door opening height is 39.75".	2	2	BDD30x34.5, 40.5, 60
		2	2	BDD33x34.5, 40.5, 60
2		2	BDD36x34.5, 40.5, 60	
	BASE DRAWER (2)			
	Two equal drawer opening heights 12 3/4".	2		BD(2)09
	NOTE: Modify drawer opening height using modification – DWR OP HT D1-D2 (10%) Modify drawer height using modification – DWR HT D1-D2(10%)	2		BD(2)12
		2		BD(2)15
		2		BD(2)18
		2		BD(2)21
		2		BD(2)24
		2		BD(2)27
		2		BD(2)30
		2		BD(2)33
	2		BD(2)36	
	BASE DRAWER (3) 34.5", 40.5" HIGH			
	34.5" high cabinet: One small drawer opening height is 4.875" and two large drawer opening heights are 9.5625".	3		BD(3)09x34.5, 40.5
		3		BD(3)12x34.5, 40.5
		3		BD(3)15x34.5, 40.5
	40.5" high cabinet: One small drawer opening height is 4.875" and two large drawer opening heights are 12.5625".	3		BD(3)18x34.5, 40.5
		3		BD(3)21x34.5, 40.5
		3		BD(3)24x34.5, 40.5
	NOTE: Modify drawer opening height using modification – DWR OP HT D1-D3 (10%) Modify drawer height using modification – DWR HT D1-D3(10%)	3		BD(3)27x34.5, 40.5
		3		BD(3)30x34.5, 40.5
		3		BD(3)33x34.5, 40.5
	3		BD(3)36x34.5, 40.5	

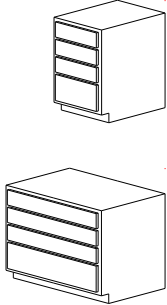
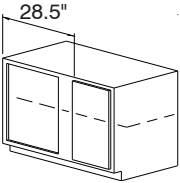
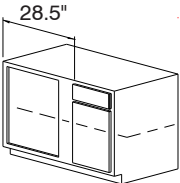
Bases

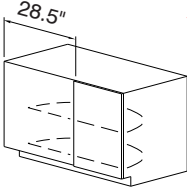
Cabinets are 34.5" high by 24" deep unless specified. Model number indicates width. Special height is shown by stating number of inches after width. Special depth is specified after width or height by a dash and the number of inches deep.		DRAWERS	DOORS	
	BASE DRAWER (4) 34.5", 40.5", 60" HIGH			
	34.5" high cabinet: Three small drawer opening heights are 4.875" and one large drawer opening height is 7.875".	4		BD(4)09x34.5, 40.5, 60
		4		BD(4)12x34.5, 40.5, 60
		4		BD(4)15x34.5, 40.5, 60
	40.5" high cabinet: One small drawer opening height is 4.875" and three large drawer opening heights are 7.875".	4		BD(4)18x34.5, 40.5, 60
		4		BD(4)21x34.5, 40.5, 60
		4		BD(4)24x34.5, 40.5, 60
	60" high cabinet: One small drawer opening height is 4.875" and three large drawer opening heights are 14.375".	4		BD(4)27x34.5, 40.5, 60
		4		BD(4)30x34.5, 40.5, 60
		4		BD(4)33x34.5, 40.5, 60
	4		BD(4)36x34.5, 40.5, 60	
NOTE: Modify drawer opening height using modification – DWR OP HT D1-D4 (10%) Modify drawer height using modification – DWR HT D1-D4(10%)				
 <p>LEFT HAND BLIND SHOWN</p>	BASE BLIND CORNER FULL DOOR 34.5", 40.5", 60" HIGH			
	Specify hinge direction. Standard hinging is on blind side. Indicate blind left or right. Cabinet can be pulled up to 3" from the corner.		1	BBCFD-LT 39x34.5, 40.5, 60
			1	BBCFD-LT 42x34.5, 40.5, 60
			1	BBCFD-LT 45x34.5, 40.5, 60
	34.5" high cabinet, one adjustable shelf, 18.5" deep. 40.5" high cabinet, two adjustable shelves, 18.5" deep. 60" high cabinet, three adjustable shelves, 18.5" deep.		1	BBCFD-LT 48x34.5, 40.5, 60
			1	BBCFD-RT 39x34.5, 40.5, 60
			1	BBCFD-RT 42x34.5, 40.5, 60
			1	BBCFD-RT 45x34.5, 40.5, 60
			1	BBCFD-RT 48x34.5, 40.5, 60
	MODIFICATIONS: FLUSH BLIND: Specify for flush blind if needed.			
Adjacent cabinet needs filler or extended stile. NOTE: for Inset Cabinet Door, blind width is 27".			FLUSH BLIND	
 <p>LEFT HAND BLIND SHOWN</p>	BASE BLIND CORNER 34.5", 40.5", 60" HIGH			
	Specify hinge direction. Standard hinging is on blind side. Indicate blind left or right. Cabinet can be pulled up to 3" from the corner.	1	1	BBC-LT 39x34.5, 40.5, 60
		1	1	BBC-LT 42x34.5, 40.5, 60
		1	1	BBC-LT 45x34.5, 40.5, 60
	34.5" high cabinet, one adjustable shelf, 18.5" deep. 40.5" high cabinet, two adjustable shelves, 18.5" deep. 60" high cabinet, three adjustable shelves, 18.5" deep.	1	1	BBC-LT 48x34.5, 40.5, 60
		1	1	BBC-RT 39x34.5, 40.5, 60
		1	1	BBC-RT 42x34.5, 40.5, 60
		1	1	BBC-RT 45x34.5, 40.5, 60
		1	1	BBC-RT 48x34.5, 40.5, 60
	MODIFICATIONS: FLUSH BLIND: Specify for flush blind if needed.			
Adjacent cabinet needs filler or extended stile. For Inset Cabinet Door, blind width is 27". NOTE: Modify drawer opening height using modification – DWR OP HT (10%) Modify drawer height using modification – DWR HT (10%)			FLUSH BLIND	

Cabinets are 34.5" high by 24" deep unless specified. Model number indicates width. Special height is shown by stating number of inches after width. Special depth is specified after width or height by a dash and the number of inches deep.		DRAWERS	DOORS	
 <p>28.5"</p> <p>LEFT HAND BLIND SHOWN</p>	BASE BLIND CORNER LAZY SUSAN BASE BLIND CORNER FULL DOOR LAZY SUSAN			
	<p>Lazy Susan consists of one or two revolving shelves with textured maple melamine and chrome fence rail. Fits in standard base blind corner or base blind corner full door cabinet with 18" door opening and a minimum cabinet depth of 24".</p> <p>NOTE: BBC (LS) will have only one susan, a standard shelf can be ordered separately.</p> 	<p>1 1 BBC(LS)LT 48</p> <p>1 1 BBC(LS)RT 48</p>		
			<p>1 BBCFD(LS)LT 48</p> <p>1 BBCFD(LS)RT 48</p>	
	BASE BLIND CORNER PULL OUT PANTRY BASE BLIND CORNER FULL DOOR PO PANTRY			
	<p>Fits in standard Base Blind Corner Full Door cabinet with a minimum 15.625" or 19.375" wide door opening and a minimum cabinet depth of 21". Door attaches to the unit.</p> <p>Baskets with maple melamine non-slip surface and chrome fence rail. Maximum load per shelf: Back 20 lbs. per basket, Front 15 lbs. per basket.</p> <p>Basket Sizes:</p> <p>15 5/8" w opng: 19 3/8" w opng:</p> <p>2 - 11 5/8" x 18 1/2" x 3 1/2" 2 - 15 3/8" x 18 1/2" x 3 1/2"</p> <p>2 - 15 3/8" x 18 1/2" x 3 1/2" 2 - 15 3/8" x 18 1/2" x 3 1/2"</p>	<p>1 BBCFD(PP-CHR)LT 45</p> <p>1 BBCFD(PP-CHR)LT 48</p>		
			<p>1 BBCFD(PP-CHR)RT 45</p> <p>1 BBCFD(PP-CHR)RT 48</p>	

Bases

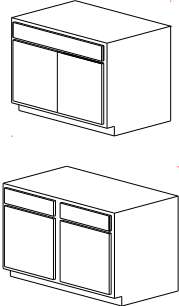
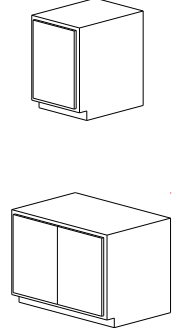
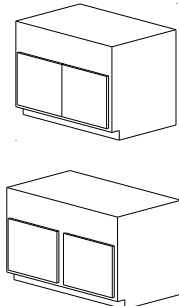
Cabinets are 34.5" high by 24" deep unless specified. Model number indicates width. Special height is shown by stating number of inches after width. Special depth is specified after width or height by a dash and the number of inches deep.		DRAWERS	DOORS	
	BASE SINK 34.5", 40.5", 60" HIGH			
	No shelves. False fronts-no drawers.	1	1	BS18x34.5, 40.5, 60
	Cabinets 39" wide thru 48" wide have a 3" wide center stile.	1	1	BS21x34.5, 40.5, 60
		1	1	BS24x34.5, 40.5, 60
	NOTE: Modify drawer opening height using modification-DWR OP HT (10%)	1	2	BS27x34.5, 40.5, 60
		1	2	BS30x34.5, 40.5, 60
		1	2	BS33x34.5, 40.5, 60
		1	2	BS36x34.5, 40.5, 60
		2	2	BS39x34.5, 40.5, 60
		2	2	BS42x34.5, 40.5, 60
	2	2	BS45x34.5, 40.5, 60	
	2	2	BS48x34.5, 40.5, 60	
	BASE SINK FULL DOOR 34.5", 40.5", 60" HIGH			
	No shelves. Sink apron behind doors, maximum 6"h. Sink apron is not present with Inset Door applications.		1	BSFD18x34.5, 40.5, 60
			1	BSFD21x34.5, 40.5, 60
			1	BSFD24x34.5, 40.5, 60
	Cabinets 39" wide thru 48" wide have a 3" wide center stile.		2	BSFD27x34.5, 40.5, 60
			2	BSFD30x34.5, 40.5, 60
			2	BSFD33x34.5, 40.5, 60
			2	BSFD36x34.5, 40.5, 60
			2	BSFD39x34.5, 40.5, 60
			2	BSFD42x34.5, 40.5, 60
		2	BSFD45x34.5, 40.5, 60	
		2	BSFD48x34.5, 40.5, 60	
	BASE APRON SINK			
	No shelves. Cabinet has wide top rail to accommodate an apron sink. Specify height of top rail. Cut-out for sink to be done jobsite.		1	BAS18
			1	BAS21
			1	BAS24
	Cabinets 39" wide thru 48" wide have a 3" wide center stile.		2	BAS27
			2	BAS30
			2	BAS33
			2	BAS36
			2	BAS39
			2	BAS42
		2	BAS45	
		2	BAS48	

Bases

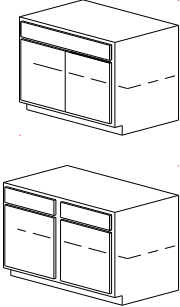
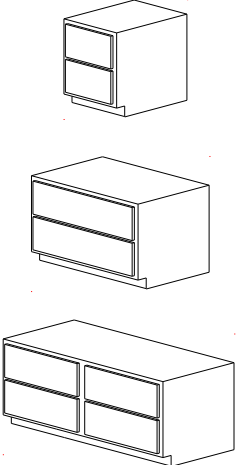
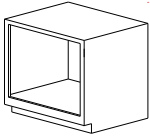
Cabinets are 34.5" high by 24" deep unless specified. Model number indicates width. Special height is shown by stating number of inches after width. Special depth is specified after width or height by a dash and the number of inches deep.		DRAWERS	DOORS		
	BASE RANGE				
	One adjustable shelf 18.5" deep. False fronts-no drawers.	1 1 1	1 1 1	BR18 BR21 BR24	
	Cabinets 39" thru 48" wide have a 3" wide center stile.	1 1 1	2 2 2	BR27 BR30 BR33	
	NOTE: Modify drawer opening height using modification- DWR OP HT (10%)	1 2 2 2 2	2 2 2 2 2	BR36 BR39 BR42 BR45 BR48	
		BASE RANGE TOP (Specify height)			
		Specify cabinet height to accommodate range top. Cabinet has flush top.	2 2 2		BRT30 x HT BRT33 x HT BRT36 x HT
		Cabinets 30 thru 42 wide have two equal height drawers. Cabinets 45 and 48 wide have a 3" wide center stile between drawers and four equal height drawers.	2 2		BRT39 x HT BRT42 x HT
		Cabinets 39" and 42" wide have Tandem Full Extension Heavy Duty slides.	4 4		BRT45 x HT BRT48 x HT
		NOTE: Modify drawer opening height using modification – DWR OP HT D1-D2 (10%) Modify drawer height using modification – DWR HT D1-D2(10%)			
			BASE OVEN 34.5", 40.5" HIGH		
Specify cut-out size. Maximum cut-out width is 2" less than cabinet width. Cabinet has 1.5" top rail and bottom rail varies due to cut-out height.					BO27x34.5, 40.5 BO30x34.5, 40.5 BO33x34.5, 40.5 BO36x34.5, 40.5
34.5"h cabinet: Maximum cut-out height is 27".					
40.5"h cabinet: Maximum cut-out height is 33".					



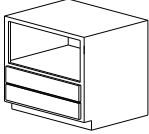
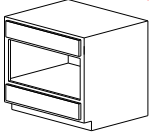
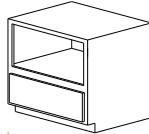
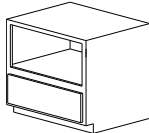

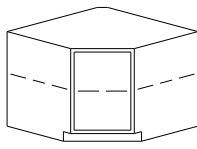
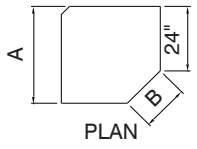
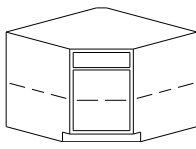
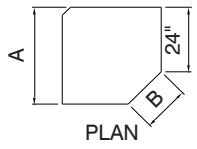
Bases

Cabinets are 34.5" high by 24" deep unless specified. Model number indicates width. Special height is shown by stating number of inches after width. Special depth is specified after width or height by a dash and the number of inches deep.		DRAWERS	DOORS	
	BASE WARMING OVEN WITH DRAWERS 34.5", 40.5" HIGH			
	Specify cut-out size. Maximum cut-out width is 2" less than cabinet width. Cabinet has 1.5" top and bottom rail at cut-out.	2		BWOD27x34.5, 40.5
	34.5"h cabinet: Maximum cut-out height is 14.5". Drawer opening heights are equal and vary in height due to cut-out size.	2		BWOD30x34.5, 40.5
		2		BWOD33x34.5, 40.5
		2		BWOD36x34.5, 40.5
	BASE WARMING OVEN WITH TOP DRAWER 34.5", 40.5" HIGH			
	Specify cut-out size. Maximum cut-out width is 2" less than cabinet width. Cabinet has 1.5" top and bottom rail at cut-out.	2		BWOTD27x34.5, 40.5
	34.5"h cabinet: Maximum cut-out height is 14.5". Top drawer opening height is 4.875". Bottom drawer opening height varies due to cut-out size.	2		BWOTD30x34.5, 40.5
		2		BWOTD33x34.5, 40.5
		2		BWOTD36x34.5, 40.5
	BASE MICROWAVE DRAWER 34.5", 40.5" HIGH			
	Specify cut-out size. Maximum cut-out width is 2" less than cabinet width. Cabinet has 1.5" top rail and 3" bottom rail at cut-out.	1		BMD27x34.5, 40.5
	34.5"h cabinet: Maximum cut-out height is 19.125". Drawer opening height varies due to cut-out size.	1		BMD30x34.5, 40.5
		1		BMD33x34.5, 40.5
		1		BMD36x34.5, 40.5
	BASE MICROWAVE DRAWER-OPEN SHELF 34.5", 40.5" HIGH			
	Drawer opening height varies due to open shelf area height. Open shelf area width is 3" less than cabinet width. Specify height of open shelf area. Cabinet interior has same wood and finish as exterior.	1		BMD-OS27x34.5, 40.5
	NOTE: Modify drawer opening height using modification – DWR OP HT (10%)	1		BMD-OS30x34.5, 40.5
	Modify drawer height using modification – DWR HT (10%)	1		BMD-OS33x34.5, 40.5
		1		BMD-OS36x34.5, 40.5

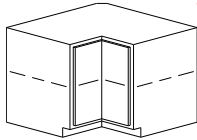
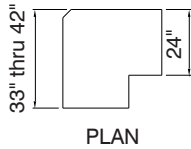
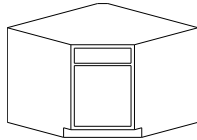
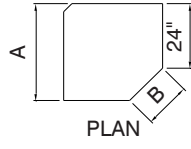
Cabinets are 34.5" high by 24" deep unless specified. Model number indicates width. Special height is shown by stating number of inches after width. Special depth is specified after width or height by a dash and the number of inches deep.		DRAWERS	DOORS																	
  <p>PLAN</p>	BASE DIAGONAL CORNER FULL DOOR																			
	One fixed shelf. Cabinet back dimension is 33" x 33" thru 42" x 42". Specify hinging on single door cabinet. BDCFD42 has two doors.			1	BDCFD33															
				1	BDCFD36															
				1	BDCFD39															
				2	BDCFD42															
	SIZE CHART <table border="1"> <thead> <tr> <th>Dim. A</th> <th>Dim. B</th> <th>Door Opening Width</th> </tr> </thead> <tbody> <tr> <td>33"</td> <td>12 3/4"</td> <td>9 1/4"</td> </tr> <tr> <td>36"</td> <td>17"</td> <td>13 1/2"</td> </tr> <tr> <td>39"</td> <td>21 1/4"</td> <td>17 3/4"</td> </tr> <tr> <td>42"</td> <td>25 1/2"</td> <td>22"</td> </tr> </tbody> </table>			Dim. A	Dim. B	Door Opening Width	33"	12 3/4"	9 1/4"	36"	17"	13 1/2"	39"	21 1/4"	17 3/4"	42"	25 1/2"	22"		NTK
	Dim. A	Dim. B	Door Opening Width																	
	33"	12 3/4"	9 1/4"																	
	36"	17"	13 1/2"																	
	39"	21 1/4"	17 3/4"																	
42"	25 1/2"	22"																		
CAUTION: No Toe Kick (NTK) modification may be required for access to installation area. Toe kick blocking (TKB) is available, in 96" lengths, for constructing sub base.				TKB																
  <p>PLAN</p>	BASE DIAGONAL CORNER																			
	One fixed shelf. Cabinet back dimension is 33" x 33" thru 42" x 42". Specify hinging on single door cabinet. BDC42 has one drawer and two doors.			1	1	BDC33														
				1	1	BDC36														
				1	1	BDC39														
				1	2	BDC42														
	See SIZE CHART under Base Diagonal Corner Full Door for Plan Dimensions.					NTK														
	CAUTION: No Toe Kick (NTK) modification may be required for access to installation area. Toe kick blocking (TKB) is available, in 96" lengths, for constructing sub base on jobsite.					TKB														
	NOTE: Modify drawer opening height using modification – DWR OP HT (10%) Modify drawer height using modification – DWR HT (10%)																			

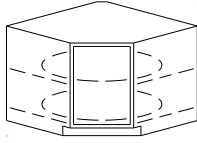
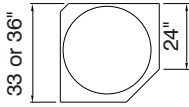

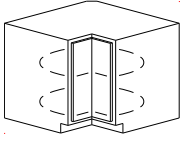

Bases

Cabinets are 34.5" high by 24" deep unless specified. Model number indicates width. Special height is shown by stating number of inches after width. Special depth is specified after width or height by a dash and the number of inches deep.		DRAWERS	DOORS	
  <p>PLAN</p>	<p>BASE SQUARE CORNER FULL DOOR</p> <p>One fixed shelf. Cabinet back dimension is 33" x 33" thru 42" x 42".</p> <p>Hinging method is Square Corner Bifold Door. Specify hinge direction - left or right.</p> <p>CAUTION: Check door width sizes available when choosing a door style for BSCFD33. No Toe Kick (NTK) modification may be required for access to installation area. Toe kick blocking (TKB) is available, in 96" lengths, for constructing sub base on jobsite.</p>			
			2	BSCFD33
			2	BSCFD36
			2	BSCFD39
			2	BSCFD42
				NTK
				TKB
  <p>PLAN</p>	<p>BASE DIAGONAL CORNER SINK</p> <p>No shelves. Cabinet back dimension is 36" x 36" thru 42" x 42". Specify hinging on single door cabinet. BDCS42 has one false front and two doors.</p> <p>See SIZE CHART under Base Diagonal Corner Full Door for Plan Dimensions.</p> <p>CAUTION: No Toe Kick (NTK) modification may be required for access to installation area. Toe kick blocking (TKB) is available, in 96" lengths, for constructing sub base on jobsite.</p> <p>NOTE: Modify drawer opening height using modification- DWR OP HT (10%)</p>			
		1	1	BDCS36
		1	1	BDCS39
		1	2	BDCS42
				NTK
				TKB

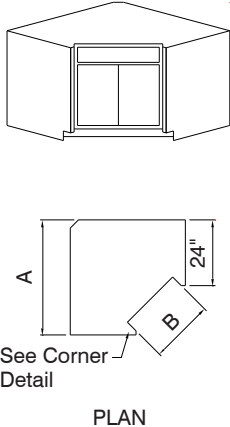
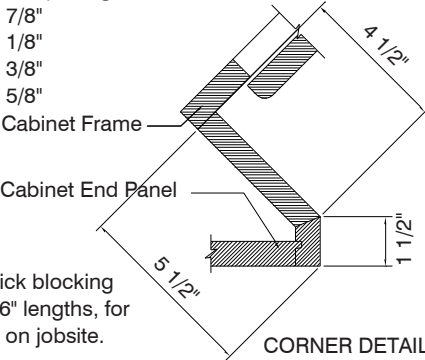
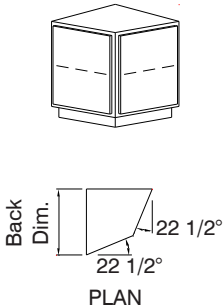
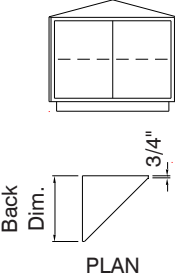

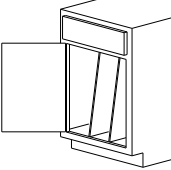
Cabinets are 34.5" high by 24" deep unless specified. Model number indicates width. Special height is shown by stating number of inches after width. Special depth is specified after width or height by a dash and the number of inches deep.		DRAWERS	DOORS	
BASE DIAGONAL CORNER WOOD LAZY SUSAN				
  PLAN	Specify hinge direction. Two 32" diameter wood revolving shelves in a natural finish. Fits in standard base diagonal corner full door cabinet 33 or 36" wide with a minimum cabinet depth of 24".		1 BDCWL33 1 BDCWL36	
	CAUTION: Cabinet requires a minimum 35" wide access to installation area. No Toe Kick (NTK) modification may be specified to clear 31" wide access. Toe kick blocking (TKB) is available for field installation. TKB is a 6" x 6" x 4 1/2" high corner block.			
 FULL ROUND (Wood)				
BASE SQUARE CORNER WOOD LAZY SUSAN				
  PLAN	Doors open 170°. Doors are hinged together making a bifold. Specify hinge direction - left or right. Two 32" diameter (kidney shape) wood revolving shelves in a natural finish. Fits in standard base square corner sink cabinet 33" or 36" wide with a minimum cabinet depth of 24".		1 BSCWL33 1 BSCWL36	
	CAUTION: Cabinet requires a minimum 35" wide access to installation area. No Toe Kick (NTK) modification may be specified to clear 31" wide access. Toe kick blocking (TKB) is available for field installation. TKB is a 6" x 6" x 4 1/2" high corner block.			
 KIDNEY (Wood)				





Bases

Cabinets are 34.5" high by 24" deep unless specified. Model number indicates width. Special height is shown by stating number of inches after width. Special depth is specified after width or height by a dash and the number of inches deep.		DRAWERS	DOORS																
 <p>BASE DIAGONAL CORNER RECESSED SINK</p> <p>No shelves. Cabinet back dimension is 39" x 39" thru 48" x 48". BDCRS39 is designed for single bowl sink. BDCRS42 and BDCRS48 are designed for double bowl sinks. Specify hinging on single door cabinet. BDCRS42 thru 48 have one false front and two doors.</p> <p>SIZE CHART</p> <table border="1"> <thead> <tr> <th>Dim. A</th> <th>Dim. B</th> <th>Door Opening Width</th> </tr> </thead> <tbody> <tr> <td>39"</td> <td>19 1/8"</td> <td>15 7/8"</td> </tr> <tr> <td>42"</td> <td>23 3/8"</td> <td>20 1/8"</td> </tr> <tr> <td>45"</td> <td>27 5/8"</td> <td>24 3/8"</td> </tr> <tr> <td>48"</td> <td>31 7/8"</td> <td>28 5/8"</td> </tr> </tbody> </table> <p>CAUTION: No Toe Kick (NTK) modification may be required for access to installation area. Toe kick blocking (TKB) is available, in 96" lengths, for constructing sub base on jobsite.</p> <p>NOTE: Modify drawer opening height using modification-DWR OP HT (10%)</p> 	Dim. A	Dim. B	Door Opening Width	39"	19 1/8"	15 7/8"	42"	23 3/8"	20 1/8"	45"	27 5/8"	24 3/8"	48"	31 7/8"	28 5/8"	<p>BASE DIAGONAL CORNER RECESSED SINK</p>			
	Dim. A	Dim. B	Door Opening Width																
	39"	19 1/8"	15 7/8"																
	42"	23 3/8"	20 1/8"																
	45"	27 5/8"	24 3/8"																
48"	31 7/8"	28 5/8"																	
	No shelves. Cabinet back dimension is 39" x 39" thru 48" x 48". BDCRS39 is designed for single bowl sink. BDCRS42 and BDCRS48 are designed for double bowl sinks. Specify hinging on single door cabinet. BDCRS42 thru 48 have one false front and two doors.	1	1	BDCRS39															
		1	2	BDCRS42															
		1	2	BDCRS45															
		1	2	BDCRS48															
				NTK															
				TKB															
 <p>BASE ANGLE CORNER</p> <p>34.5", 40.5", 60" HIGH</p> <p>Finished end panels not available.</p> <p>34.5" high cabinet, one adjustable shelf. 40.5" high cabinet, two adjustable shelves. 60" high cabinet, three adjustable shelves.</p> <table border="1"> <thead> <tr> <th>Cabinet Back Dimension</th> <th>Cabinet Door Opening Width</th> </tr> </thead> <tbody> <tr> <td>18" x 18"</td> <td>10 3/8"</td> </tr> <tr> <td>21" x 21"</td> <td>12 11/16"</td> </tr> <tr> <td>24" x 24"</td> <td>15"</td> </tr> </tbody> </table>	Cabinet Back Dimension	Cabinet Door Opening Width	18" x 18"	10 3/8"	21" x 21"	12 11/16"	24" x 24"	15"	<p>BASE ANGLE CORNER</p> <p>34.5", 40.5", 60" HIGH</p>										
	Cabinet Back Dimension	Cabinet Door Opening Width																	
	18" x 18"	10 3/8"																	
	21" x 21"	12 11/16"																	
	24" x 24"	15"																	
	Finished end panels not available.		2	BAC18x34.5, 40.5, 60															
			2	BAC21x34.5, 40.5, 60															
			2	BAC24x34.5, 40.5, 60															
 <p>BASE CORNER</p> <p>34.5", 40.5", 60" HIGH</p> <p>Finished end panels not available.</p> <p>34.5" high cabinet, one adjustable shelf. 40.5" high cabinet, two adjustable shelves. 60" high cabinet, three adjustable shelves.</p> <table border="1"> <thead> <tr> <th>Cabinet Back Dimension</th> <th>Cabinet Door Opening Width</th> </tr> </thead> <tbody> <tr> <td>18" x 18"</td> <td>20 7/8"</td> </tr> <tr> <td>21" x 21"</td> <td>25 1/8"</td> </tr> <tr> <td>24" x 24"</td> <td>29 3/8"</td> </tr> </tbody> </table>	Cabinet Back Dimension	Cabinet Door Opening Width	18" x 18"	20 7/8"	21" x 21"	25 1/8"	24" x 24"	29 3/8"	<p>BASE CORNER</p> <p>34.5", 40.5", 60" HIGH</p>										
	Cabinet Back Dimension	Cabinet Door Opening Width																	
	18" x 18"	20 7/8"																	
	21" x 21"	25 1/8"																	
	24" x 24"	29 3/8"																	
	Finished end panels not available.		1	BC18x34.5, 40.5, 60															
			2	BC21x34.5, 40.5, 60															
			2	BC24x34.5, 40.5, 60															

Cabinets are 34.5" high by 24" deep unless specified. Model number indicates width. Special height is shown by stating number of inches after width. Special depth is specified after width or height by a dash and the number of inches deep.		DRAWERS	DOORS	
 <p>BASE TRAY DIVIDER BASE FULL DOOR TRAY DIVIDER</p> <p>Standard tray dividers are .5" thick by 16" high and equally spaced in cabinet opening. Dividers are same finish as cabinet interior.</p> <p>Cabinet 09" thru 12" wide, 1 divider Cabinet 15" wide, 2 dividers Cabinet 18" thru 21" wide, 3 dividers</p>				
	1	1	B(TD)09	
	1	1	B(TD)12	
	1	1	B(TD)15	
	1	1	B(TD)18	
	1	1	B(TD)21	
		1	BFD(TD)09	
	1	BFD(TD)12		
	1	BFD(TD)15		
	1	BFD(TD)18		
	1	BFD(TD)21		
 <p>BASE ROLL-OUT WASTE BASKET BASE FULL DOOR ROLL-OUT WASTE BASKET</p> <p>Fits in standard 24" deep base cabinet. Roll-out waste baskets are made from natural finish solid wood with dovetail construction and are bottom mounted with Blum 150lb soft-close undermount slides. RWB is door mounted.</p> <p>RWB15 fits 12"-15" opening width and has a single 35 qt. wastebasket & rear storage compartment</p> <p>RWB(2)18 fits 15"-18" opening width and has double 35 qt. wastebaskets</p> <p>RWB(2)21 fits 18"-21" opening width and has double 35 qt. wastebaskets</p>				
	1	1	B(RWB) 15	
	1	1	B(RWB-2) 18	
	1	1	B(RWB-2) 21	
		1	BFD(RWB) 15	
		1	BFD(RWB-2) 18	
	1	BFD(RWB-2) 21		
 <p>BASE ROLL-OUT WASTE BASKET - Walnut BASE FULL DOOR ROLL-OUT WASTE BASKET</p> <p>Fits in standard 24" deep base cabinet. Roll-out waste baskets are made from walnut solid wood frame in a natural finish with dovetail construction and feature MOVENTO over-travel, 132 lb concealed slides with BLUMOTION. RWB is door mounted. Waste containers are Orion Gray.</p> <p>RWB15 fits 12" opening width and has a single 35 qt. or 50 qt. wastebasket, matching lid & rear storage compartment</p> <p>RWB(2)18 fits 15" opening width and has double 35 qt. or 50 qt. wastebaskets with one matching lid.</p> <p>NOTE: This unit is not compatible with inset cabinetry.</p> 				
	1	1	B(RWB)W 15	
	1	1	B(RWB-2)W 18	
		1	BFD(RWB)W 15	
		1	BFD(RWB-2)W 18	



Bases

Cabinets are 34.5" high by 24" deep unless specified. Model number indicates width. Special height is shown by stating number of inches after width. Special depth is specified after width or height by a dash and the number of inches deep.		DRAWERS	DOORS	
	BASE SERVO-DRIVE WASTE CONTAINER BASE FULL DOOR SERVO DRIVE WASTE CONT.			
	Fits in standard 24" deep base cabinet. Dovetail solid wood drawer box with Blum Soft-close slides and Servo-Drive "touch to open" action. Uses standard 110V wall socket.	1	1	B(WCSD-35S)15
		1	1	B(WCSD-35D)18
	35 qt. metallic silver waste bins: Single fits in 15" cabinet Double fits in 18" cabinet		1	BFD(WCSD-50S)15
			1	BFD(WCSD-50D)21
	50 qt. metallic silver waste bins: Single fits in 15" full height door cabinet. Double fits in 21" full height door cabinet.			
	BASE PULL-OUT WASTE BIN BASE FULL DOOR PULL-OUT WASTE BIN			
	Fits in standard 24" deep base cabinet. Pull-Out Waste Bins are bottom mounted with heavy-duty, under-mount slides with soft-close technology (load capacity 100 lbs). PWBS15 has one 36 qt. silver grey container. PWBD18 has two 36 qt. silver grey containers.	1	1	B(PWBS)15
		1	1	B(PWBD)18
	Overall size: PWBS15 is 11 1/2" w x 19 3/16" h x 22 3/8" d. PWBD18 is 14" w x 19 3/16" h x 22 3/8" d.		1	BFD(PWBS)15
			1	BFD(PWBD)18
	NOTE: PWBS & PWBD not compatible with tip-on feature.			

Cabinets are 34.5" high by 24" deep unless specified. Model number indicates width. Special height is shown by stating number of inches after width. Special depth is specified after width or height by a dash and the number of inches deep.		DRAWERS	DOORS	
 <p>BASE COOKWARE ORGANIZER BASE FULL DOOR COOKWARE ORGANIZER</p> <p>Fits in standard 15" or 24" base cabinet with a minimum cabinet depth of 24".</p> <p>Cookware Organizer with two independently operating tiers made with heavy duty chrome plated wire. The top tier holds up to 7 lids, and the bottom tier features adjustable dividers to store a variety fo larger pots and pans. Organizer features full extension 100 lb. ball-bearing slides.</p> <p>Overall size is 11 3/4" or 20 3/4" w x 18 1/8" h x 22" d</p>				
		1	1	B(CO)15
		1	1	B(CO)24
			1	BFD(CO)15
			1	BFD(CO)24
 <p>BASE FOOD STORAGE CONT ORGANIZER BASE FULL DOOR FOOD STOR CONT ORGAN</p> <p>Fits in standard base or base full door cabinet with 15" or 21" door opening (18" or 24" cabinet) and a minimum cabinet depth of 24".</p> <p>Wood pull-out unit with dovetail construction and chrome accents. Adjustable clip-on lid dividers and peg board bottom. Blum undermount soft-close slides.</p>				
		1	1	B(FSCO)18
		1	1	B(FSCO)24
			1	BFD(FSCO)18
			1	BFD(FSCO)24
 <p>BASE FULL DOOR PULL-OUT ORGANIZER</p> <p>Fits in standard base full door cabinet with 9" door opening (12" cabinet) and a minimum cabinet depth of 24".</p> <p>Wood pull-out unit with stainless steel panel and an array of accessory pegs and hooks or organization. Organizer has full extension 150 lb slides. Specify left or right hand unit.</p> <p>Overall size is 8" w x 25 1/2" h x 22 1/2" d</p> <p>PBO-LT shown</p>				
			1	BFD(PO-LT)12
			1	BFD(PO-RT)12
 <p>BASE PULL-OUT TRAY DIVIDER BASE FULL DOOR PULL-OUT TRAY DIVIDER</p> <p>Fits in standard base or base full door cabinet with 6" or 9" door opening (9" or 12" cabinet) and a minimum cabinet depth of 24".</p> <p>Wood & chrome pull-out unit features two compartments for storing baking sheets and platters. A removable center rack allows you the ability to store larger platters and bake ware if desired. Organizer has full extension 150 lb slides.</p> <p>Overall size is 5" or 8" w x 19 1/2" h x 22 1/2" d</p>				
		1	1	B(POTD)09
		1	1	B(POTD)12
			1	BFD(POTD)09
			1	BFD(POTD)12

Bases

Cabinets are 34.5" high by 24" deep unless specified. Model number indicates width. Special height is shown by stating number of inches after width. Special depth is specified after width or height by a dash and the number of inches deep.		DRAWERS	DOORS		
	BASEFULL DOOR PULL-OUT PANTRY				
	Fits in standard 24" deep base full door cabinet with 6", 9" or 12" door opening (9", 12", or 15" cabinet).		1	BFD(PP-WD)09	
	Four tier pull-out pantry with natural maple shelves with chrome fence rail attached to door. Full extension, 110 lb. rated slides with BLUMOTION.		1	BFD(PP-WD)12	
	Trays are adjustable.		1	BFD(PP-WD)15	
	Optional Spice Rack accessory is available for 12" and 15" units. Spice Rack features a unique angle design for easy spice access.			SR 12 SR 15	
	BASE FULL DOOR PULL-OUT OXO® CONTAINER				
	Fits in standard 24" deep base full door cabinet with 9" door opening (12" cabinet).		1	BFD(PP-OXO)12	
	Two tier pull-out pantry with natural maple shelves with OXO® Good Grips POP containers. Door mounted, pull-out has Blum soft-close slides.				
	Top: 1-2.6 qt. and 3-1.7 qt. containers included Bottom: 3-4.3 qt. containers included.				
	BASE FULL DOOR PULL-OUT UTENSIL BIN ORGANIZER				
	Fits in standard 24" deep base full door cabinet with 6" or 9" door opening (9" or 12" cabinet).		1	BFD(PP-UT)09	
	Two tier pull-out pantry with natural maple shelves with three 1 1/4 qt. stainless steel bins in top shelf. Door mounted, pull-out has full extension, 110 lb. rated slides with BLUMOTION.		1	BFD(PP-UT)12	

Cabinets are 34.5" high by 24" deep unless specified. Model number indicates width. Special height is shown by stating number of inches after width. Special depth is specified after width or height by a dash and the number of inches deep.		DRAWERS	DOORS	
	BASE FULL DOOR PULL-OUT KNIFE AND UTENSIL BIN ORGANIZER			
	<p>Fits in standard 24" deep base full door cabinet with 9" or 12" door opening (12" or 15" cabinet).</p> <p>Two tier pull-out pantry with natural maple shelves with knife insert and stainless steel bins in top shelf. Door mounted, pull-out has Blum soft-close slides.</p> <p>12" wide cabinet: 1-5.25" w x 6.875" d bin included. 15" wide cabinet: 2-5.25" w x 6.875" d and 2-5" w x 5.875" d bins included.</p> <p>Overall size is 8" or 11" w x 25.5"h x 21.625" d</p>	1 1	BFD(PP-KB)12 BFD(PP-KB)15	
	BASE WOOD TAMBOUR TABLE BASE DRAWER (3) WOOD TAMBOUR TABLE			
	<p>This pull-out wood tambour table is designed to be used in the top drawer opening of a 24" wide base or base drawer cabinet. The mechanical slide features stop locks to extend up to 31 3/4"</p>	1 3	1	B(WTT)24 BD(3)(WTT)24

Bases

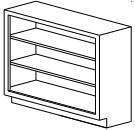
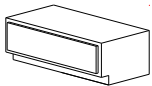
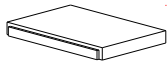
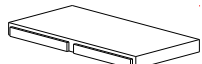
Cabinets are 34.5" high by 24" deep unless specified. Model number indicates width. Special height is shown by stating number of inches after width. Special depth is specified after width or height by a dash and the number of inches deep.		DRAWERS	DOORS	
	BASE BOOKCASE 34.5", 40.5", 60" HIGH, 12" DEEP			
	Cabinet interior has same finish as exterior. Cabinet is standard with a 1.5" top rail.			BB12x34.5, 40.5, 60 BB15x34.5, 40.5, 60 BB18x34.5, 40.5, 60
	34.5" high cabinet, 2 shelves 40.5" high cabinet, 3 shelves 60" high cabinet, 4 shelves			BB21x34.5, 40.5, 60 BB24x34.5, 40.5, 60 BB27x34.5, 40.5, 60
	MODIFICATIONS: VAL (Style): Optional valance styles are available. HS-SWM: Shelves with edge mold are available and recommended on wide cabinets.			BB30x34.5, 40.5, 60 BB33x34.5, 40.5, 60 BB36x34.5, 40.5, 60
				VAL (Style)
				HS-SWM
	BASE WINDOW SEAT 18" HIGH, 24" DEEP			
	Drawer opening height is 10 1/2".	1		BWS12-24
	Cabinet does not include countertop.	1		BWS15-24
		1		BWS18-24
		1		BWS21-24
		1		BWS24-24
		1		BWS27-24
		1		BWS30-24
1			BWS33-24	
1		BWS36-24		
 	BASE KNEE DRAWER 4.5" HIGH			
	Cabinet does not have bottom rail. Drawer opening height is 3".	1		BKD24
	Cabinet can be supported by attached end panels. Attached end panel does not increase width of cabinet. End panel is 32" high. Specify left or right.	1		BKD27
		1		BKD30
		1		BKD33
		1		BKD36
		2		BKD39
		2		BKD42
		2		BKD45
	2		BKD48	
				BEP-A LT or RT
			BEPD-A LT or RT	
			BEPC-A LT or RT	

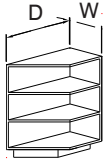
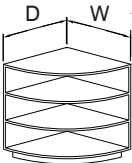
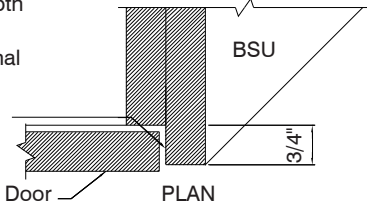
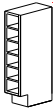
Cabinets are 34.5" high by 24" deep unless specified. Model number indicates width. Special height is shown by stating number of inches after width. Special depth is specified after width or height by a dash and the number of inches deep.		DRAWERS	DOORS																									
 <p>BSU-RT 12x34.5-24 Diagonal</p>  <p>BSU-RT 24x34.5-24 Radius</p>	<p>BASE SHELF UNIT</p> <p>All fixed shelving. Interior has same finish as exterior. Specify width, height and depth. Specify if unit is LT or RT. Specify radius or diagonal.</p> <table border="0"> <tr> <td>Unit Height</td> <td>No. of shelves</td> <td colspan="2">Height chart does not</td> </tr> <tr> <td>18" to 27"</td> <td>One</td> <td>include 4.5" TK ht</td> <td></td> </tr> <tr> <td></td> <td>to 39"</td> <td>Two</td> <td>when figuring</td> </tr> <tr> <td>number of</td> <td>to 54"</td> <td>Three</td> <td>shelves. Num-</td> </tr> <tr> <td>ber of shelves</td> <td>to 69"</td> <td>Four</td> <td>does not in-</td> </tr> <tr> <td>clude top</td> <td>to 84"</td> <td>Five</td> <td>and bottom.</td> </tr> </table> <p>Specify 3/4" additional depth if BSU is to be flush with cabinet doors. No additional charge.</p> <p>Exposed back edge is finished when specifying for the 3/4" additional depth.</p> 	Unit Height	No. of shelves	Height chart does not		18" to 27"	One	include 4.5" TK ht			to 39"	Two	when figuring	number of	to 54"	Three	shelves. Num-	ber of shelves	to 69"	Four	does not in-	clude top	to 84"	Five	and bottom.			<p>BSU-LT W x H - D BSU-RT W x H - D</p>
	Unit Height	No. of shelves	Height chart does not																									
18" to 27"	One	include 4.5" TK ht																										
	to 39"	Two	when figuring																									
number of	to 54"	Three	shelves. Num-																									
ber of shelves	to 69"	Four	does not in-																									
clude top	to 84"	Five	and bottom.																									
	<p>BASE WINE RACK</p> <p>34.5", 40.5", 60" HIGH, 12" DEEP</p> <p>Interior has same finish as exterior. Wine rack shelving is fixed.</p>			<p>BWR06x34.5, 40.5, 60</p>																								

Bases

Simplicity
Face Frame

Bases



Simplicity
Face Frame

Vanities

Vanities

Simplicity
Face Frame

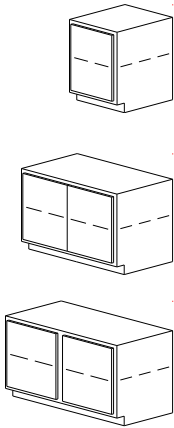
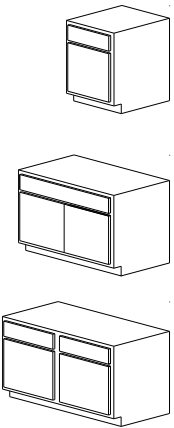
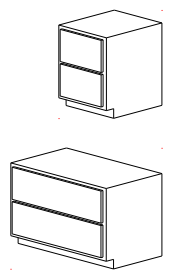
Cabinets are 32" high by 21" deep unless specified. Model number indicates width. Special height is shown by stating number of inches after width. Special depth is specified after width or height by a dash and the number of inches deep.		DRAWERS	DOORS	
	VANITY FULL DOOR 32", 34.5" HIGH			
	One adjustable shelf. Specify hinge direction on single door cabinet. Cabinets 39" thru 48" wide have a 3" wide center stile.		1	VFD09x32, 34.5
			1	VFD12x32, 34.5
			1	VFD15x32, 34.5
			1	VFD18x32, 34.5
			1	VFD21x32, 34.5
			1	VFD24x32, 34.5
			2	VFD27x32, 34.5
			2	VFD30x32, 34.5
			2	VFD33x32, 34.5
		2	VFD36x32, 34.5	
	VANITY 32", 34.5" HIGH			
	No shelf. Specify hinge direction on single door cabinet. Cabinets 39" thru 48" wide have a 3" wide center stile.	1	1	V09x32, 34.5
		1	1	V12x32, 34.5
		1	1	V15x32, 34.5
		1	1	V18x32, 34.5
		1	1	V21x32, 34.5
		1	1	V24x32, 34.5
		1	2	V27x32, 34.5
		1	2	V30x32, 34.5
		1	2	V33x32, 34.5
	1	2	V36x32, 34.5	
	VANITY DRAWER (2) 32", 34.5" HIGH			
	32" high cabinet: Two equal drawer opening heights are 11.5".	2		VD(2)09x32, 34.5
		2		VD(2)12x32, 34.5
		2		VD(2)15x32, 34.5
	34.5" high cabinet: Two equal drawer opening heights are 12.75".	2		VD(2)18x32, 34.5
		2		VD(2)21x32, 34.5
		2		VD(2)24x32, 34.5
		2		VD(2)27x32, 34.5
		2		VD(2)30x32, 34.5
		2		VD(2)33x32, 34.5
	2		VD(2)36x32, 34.5	
	NOTE: Modify drawer opening height using modification – DWR OP HT D1-D2 (10%) Modify drawer height using modification – DWR HT D1-D2(10%)			

Vanities

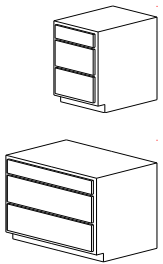
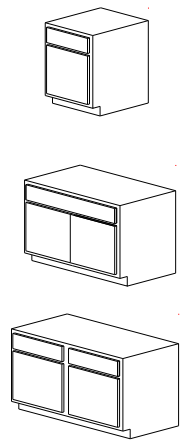
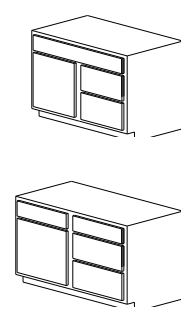
Cabinets are 32" high by 21" deep unless specified. Model number indicates width. Special height is shown by stating number of inches after width. Special depth is specified after width or height by a dash and the number of inches deep.		DRAWERS	DOORS																														
	VANITY DRAWER (3) 32", 34.5" HIGH																																
	32" high cabinet: One small drawer opening height is 4.875" Two large drawer opening heights are 8.3125".	3		VD(3)09x32, 34.5																													
		3		VD(3)12x32, 34.5																													
		3		VD(3)15x32, 34.5																													
		3		VD(3)18x32, 34.5																													
	34.5" high cabinet: One small drawer opening height is 4.875" Two large drawer opening heights are 9.5625".	3		VD(3)21x32, 34.5																													
		3		VD(3)24x32, 34.5																													
		3		VD(3)27x32, 34.5																													
		3		VD(3)30x32, 34.5																													
		3		VD(3)33x32, 34.5																													
	NOTE: Modify drawer opening height using modification – DWR OP HT D1-D3 (10%) Modify drawer height using modification – DWR HT D1-D3(10%)	3		VD(3)36x32, 34.5																													
	VANITY SINK 32", 34.5" HIGH																																
	False front, no drawer. No shelf. Cabinets 39" thru 48" wide have a 3" wide center stile and two false fronts.	1	1	VS18x32, 34.5																													
		1	1	VS21x32, 34.5																													
		1	1	VS24x32, 34.5																													
	NOTE: Modify drawer opening height using modification- DWR OP HT (10%)	1	2	VS27x32, 34.5																													
		1	2	VS30x32, 34.5																													
		1	2	VS33x32, 34.5																													
		1	2	VS36x32, 34.5																													
		2	2	VS39x32, 34.5																													
		2	2	VS42x32, 34.5																													
	2	2	VS45x32, 34.5																														
	2	2	VS48x32, 34.5																														
 <p>RIGHT HAND SHOWN</p>	VANITY SINK DRAWER (2) LEFT OR RIGHT 32", 34.5" HIGH																																
	No shelf. Plumbing must be on door side. False front, no drawer at top. Specify two drawers left or right.	3	1	VSD(2)-LT 24x32, 34.5																													
	32" high cabinet: False front opening height is 4.875". Two large drawer opening heights are 8.3125".	3	1	VSD(2)-LT 27x32, 34.5																													
		3	1	VSD(2)-LT 30x32, 34.5																													
	34.5" high cabinet: False front opening height is 4.875". Two large drawer opening heights are 9.5625".	3	1	VSD(2)-LT 33x32, 34.5																													
		3	1	VSD(2)-LT 36x32, 34.5																													
		4	1	VSD(2)-LT 39x32, 34.5																													
	NOTE: Modify drawer opening height using modification – DWR OP HT D1-D3 (10%) Modify drawer height using modification – DWR HT D1-D3(10%)	4	1	VSD(2)-LT 42x32, 34.5																													
		4	1	VSD(2)-LT 45x32, 34.5																													
		4	1	VSD(2)-LT 48x32, 34.5																													
		3	1	VSD(2)-RT 24x32, 34.5																													
		3	1	VSD(2)-RT 27x32, 34.5																													
		3	1	VSD(2)-RT 30x32, 34.5																													
		3	1	VSD(2)-RT 33x32, 34.5																													
		3	1	VSD(2)-RT 36x32, 34.5																													
		4	1	VSD(2)-RT 39x32, 34.5																													
		4	1	VSD(2)-RT 42x32, 34.5																													
	4	1	VSD(2)-RT 45x32, 34.5																														
	4	1	VSD(2)-RT 48x32, 34.5																														
<table border="0"> <thead> <tr> <th>Cab. Widths</th> <th>Drawer Widths</th> <th>Door Widths</th> </tr> </thead> <tbody> <tr><td>24"</td><td>9"</td><td>15"</td></tr> <tr><td>27"</td><td>9"</td><td>18"</td></tr> <tr><td>30"</td><td>12"</td><td>18"</td></tr> <tr><td>33"</td><td>12"</td><td>21"</td></tr> <tr><td>36"</td><td>15"</td><td>21"</td></tr> <tr><td>39"</td><td>15"</td><td>24"</td></tr> <tr><td>42"</td><td>18"</td><td>24"</td></tr> <tr><td>45"</td><td>21"</td><td>24"</td></tr> <tr><td>48"</td><td>24"</td><td>24"</td></tr> </tbody> </table>	Cab. Widths	Drawer Widths	Door Widths	24"	9"	15"	27"	9"	18"	30"	12"	18"	33"	12"	21"	36"	15"	21"	39"	15"	24"	42"	18"	24"	45"	21"	24"	48"	24"	24"			
Cab. Widths	Drawer Widths	Door Widths																															
24"	9"	15"																															
27"	9"	18"																															
30"	12"	18"																															
33"	12"	21"																															
36"	15"	21"																															
39"	15"	24"																															
42"	18"	24"																															
45"	21"	24"																															
48"	24"	24"																															

Vanities

Simplicity
Face Frame

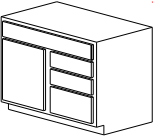
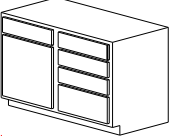
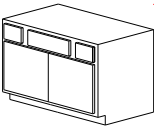
Cabinets are 32" high by 21" deep unless specified. Model number indicates width. Special height is shown by stating number of inches after width. Special depth is specified after width or height by a dash and the number of inches deep.		DRAWERS	DOORS																												
  RIGHT HAND SHOWN	VANITY SINK DRAWER(3) LEFT OR RIGHT 34.5" HIGH																														
	No shelf. Plumbing must be on door side. False front, no drawer at top. Specify three drawers left or right. Cabinets 39" thru 48" wide have a 3" wide center stile and two false fronts.	4	1	VSD(3)-LT 24x34.5																											
		4	1	VSD(3)-LT 27x34.5																											
		4	1	VSD(3)-LT 30x34.5																											
		4	1	VSD(3)-LT 33x34.5																											
		4	1	VSD(3)-LT 36x34.5																											
	Two small drawer opening heights are 4.875" and one large drawer opening height is 7.875".	5	1	VSD(3)-LT 39x34.5																											
		5	1	VSD(3)-LT 42x34.5																											
		5	1	VSD(3)-LT 45x34.5																											
		5	1	VSD(3)-LT 48x34.5																											
	NOTE: Modify drawer opening height using modification – DWR OP HT D1-D4 (10%) Modify drawer height using modification – DWR HT D1-D4(10%)	4	1	VSD(3)-RT 24x34.5																											
		4	1	VSD(3)-RT 27x34.5																											
	<table border="0"> <thead> <tr> <th>Cab. Widths</th> <th>Drawer Widths</th> <th>Door Widths</th> </tr> </thead> <tbody> <tr><td>24"</td><td>9"</td><td>15"</td></tr> <tr><td>27"</td><td>9"</td><td>18"</td></tr> <tr><td>30"</td><td>12"</td><td>18"</td></tr> <tr><td>33"</td><td>12"</td><td>21"</td></tr> <tr><td>36"</td><td>15"</td><td>21"</td></tr> <tr><td>39"</td><td>15"</td><td>24"</td></tr> <tr><td>42"</td><td>18"</td><td>24"</td></tr> <tr><td>45"</td><td>21"</td><td>24"</td></tr> </tbody> </table>	Cab. Widths	Drawer Widths	Door Widths	24"	9"	15"	27"	9"	18"	30"	12"	18"	33"	12"	21"	36"	15"	21"	39"	15"	24"	42"	18"	24"	45"	21"	24"	4	1	VSD(3)-RT 30x34.5
	Cab. Widths	Drawer Widths	Door Widths																												
	24"	9"	15"																												
	27"	9"	18"																												
	30"	12"	18"																												
33"	12"	21"																													
36"	15"	21"																													
39"	15"	24"																													
42"	18"	24"																													
45"	21"	24"																													
	4	1	VSD(3)-RT 33x34.5																												
	4	1	VSD(3)-RT 36x34.5																												
	5	1	VSD(3)-RT 39x34.5																												
	5	1	VSD(3)-RT 42x34.5																												
	5	1	VSD(3)-RT 45x34.5																												
	5	1	VSD(3)-RT 48x34.5																												
	VANITY SINK DRAWER 32", 34.5" HIGH																														
	No shelves. Cabinet has one false front and two drawers. Cabinets 39" thru 48" wide have a 3" wide center stile between doors.	3	2	VSD36x32, 34.5																											
		3	2	VSD39x32, 34.5																											
		3	2	VSD42x32, 34.5																											
	NOTE: Modify drawer opening height using modification – DWR OP HT D1-D4 (10%) Modify drawer height using modification – DWR HT D1-D4(10%)	3	2	VSD45x32, 34.5																											
		3	2	VSD48x32, 34.5																											
	<table border="0"> <thead> <tr> <th>CABINET WIDTH</th> <th>OPENING WIDTHS</th> </tr> </thead> <tbody> <tr><td>36"</td><td>6"-15"-6"</td></tr> <tr><td>39"</td><td>6"-18"-6"</td></tr> <tr><td>42"</td><td>9"-15"-9"</td></tr> <tr><td>45"</td><td>9"-18"-9"</td></tr> <tr><td>48"</td><td>9"-21"-9"</td></tr> </tbody> </table>	CABINET WIDTH	OPENING WIDTHS	36"	6"-15"-6"	39"	6"-18"-6"	42"	9"-15"-9"	45"	9"-18"-9"	48"	9"-21"-9"																		
	CABINET WIDTH	OPENING WIDTHS																													
36"	6"-15"-6"																														
39"	6"-18"-6"																														
42"	9"-15"-9"																														
45"	9"-18"-9"																														
48"	9"-21"-9"																														

Vanities

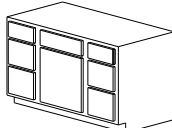
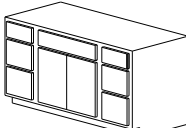
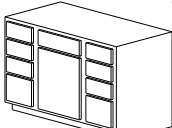
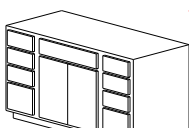

Cabinets are 32" high by 21" deep unless specified. Model number indicates width. Special height is shown by stating number of inches after width. Special depth is specified after width or height by a dash and the number of inches deep.		DRAWERS	DOORS																																	
 	VANITY SINK DOUBLE DRAWER(6) 32", 34.5" HIGH																																			
	No shelves. Cabinet has one false front. Specify hinging on single door cabinets. Cabinets 51" thru 72" wide have two doors.	7	1	VSDD(6)42x32, 34.5																																
		7	1	VSDD(6)45x32, 34.5																																
		7	1	VSDD(6)48x32, 34.5																																
	32" high cabinet: Two small drawer opening height is 4.875" Four large drawer opening heights are 8.3125".	7	2	VSDD(6)51x32, 34.5																																
		7	2	VSDD(6)54x32, 34.5																																
		7	2	VSDD(6)57x32, 34.5																																
	34.5" high Cabinet: Two small drawer opening heights are 4.875". Four large drawer opening heights are 9.5625".	7	2	VSDD(6)60x32, 34.5																																
		7	2	VSDD(6)63x32, 34.5																																
		7	2	VSDD(6)66x32, 34.5																																
		7	2	VSDD(6)69x32, 34.5																																
		7	2	VSDD(6)72x32, 34.5																																
	<table border="1"> <thead> <tr> <th>CABINET WIDTH</th> <th>OPENING WIDTHS</th> <th>CABINET WIDTH</th> <th>OPENING WIDTHS</th> </tr> </thead> <tbody> <tr> <td>36"</td> <td>6"-15"-6"</td> <td>54"</td> <td>12"-21"-12"</td> </tr> <tr> <td>39"</td> <td>6"-18"-6"</td> <td>57"</td> <td>12"-24"-12"</td> </tr> <tr> <td>42"</td> <td>9"-15"-9"</td> <td>60"</td> <td>12"-27"-12"</td> </tr> <tr> <td>45"</td> <td>9"-18"-9"</td> <td>63"</td> <td>12"-30"-12"</td> </tr> <tr> <td>48"</td> <td>9"-21"-9"</td> <td>66"</td> <td>15"-27"-15"</td> </tr> <tr> <td>51"</td> <td>9"-24"-9"</td> <td>69"</td> <td>15"-30"-15"</td> </tr> <tr> <td></td> <td></td> <td>72"</td> <td>15"-33"-15"</td> </tr> </tbody> </table>	CABINET WIDTH	OPENING WIDTHS	CABINET WIDTH	OPENING WIDTHS	36"	6"-15"-6"	54"	12"-21"-12"	39"	6"-18"-6"	57"	12"-24"-12"	42"	9"-15"-9"	60"	12"-27"-12"	45"	9"-18"-9"	63"	12"-30"-12"	48"	9"-21"-9"	66"	15"-27"-15"	51"	9"-24"-9"	69"	15"-30"-15"			72"	15"-33"-15"			
	CABINET WIDTH	OPENING WIDTHS	CABINET WIDTH	OPENING WIDTHS																																
	36"	6"-15"-6"	54"	12"-21"-12"																																
39"	6"-18"-6"	57"	12"-24"-12"																																	
42"	9"-15"-9"	60"	12"-27"-12"																																	
45"	9"-18"-9"	63"	12"-30"-12"																																	
48"	9"-21"-9"	66"	15"-27"-15"																																	
51"	9"-24"-9"	69"	15"-30"-15"																																	
		72"	15"-33"-15"																																	
NOTE: Modify drawer opening height using modification – DWR OP HT D1-D3 (10%) Modify drawer height using modification – DWR HT D1-D3(10%)																																				
 	VANITY SINK DOUBLE DRAWER(8) 34.5" HIGH																																			
	No shelves. Cabinet has one false front. Specify hinging on single door cabinets. Cabinets 51" thru 72" wide have two doors.	9	1	VSDD(8)42x34.5																																
		9	1	VSDD(8)45x34.5																																
		9	1	VSDD(8)48x34.5																																
	Six small drawer opening heights are 4.875". Two large drawer opening heights are 7.875".	9	2	VSDD(8)51x34.5																																
		9	2	VSDD(8)54x34.5																																
		9	2	VSDD(8)57x34.5																																
	<table border="1"> <thead> <tr> <th>CABINET WIDTH</th> <th>OPENING WIDTHS</th> <th>CABINET WIDTH</th> <th>OPENING WIDTHS</th> </tr> </thead> <tbody> <tr> <td>36"</td> <td>6"-15"-6"</td> <td>54"</td> <td>12"-21"-12"</td> </tr> <tr> <td>39"</td> <td>6"-18"-6"</td> <td>57"</td> <td>12"-24"-12"</td> </tr> <tr> <td>42"</td> <td>9"-15"-9"</td> <td>60"</td> <td>12"-27"-12"</td> </tr> <tr> <td>45"</td> <td>9"-18"-9"</td> <td>63"</td> <td>12"-30"-12"</td> </tr> <tr> <td>48"</td> <td>9"-21"-9"</td> <td>66"</td> <td>15"-27"-15"</td> </tr> <tr> <td>51"</td> <td>9"-24"-9"</td> <td>69"</td> <td>15"-30"-15"</td> </tr> <tr> <td></td> <td></td> <td>72"</td> <td>15"-33"-15"</td> </tr> </tbody> </table>	CABINET WIDTH	OPENING WIDTHS	CABINET WIDTH	OPENING WIDTHS	36"	6"-15"-6"	54"	12"-21"-12"	39"	6"-18"-6"	57"	12"-24"-12"	42"	9"-15"-9"	60"	12"-27"-12"	45"	9"-18"-9"	63"	12"-30"-12"	48"	9"-21"-9"	66"	15"-27"-15"	51"	9"-24"-9"	69"	15"-30"-15"			72"	15"-33"-15"	9	2	VSDD(8)60x34.5
	CABINET WIDTH	OPENING WIDTHS	CABINET WIDTH	OPENING WIDTHS																																
	36"	6"-15"-6"	54"	12"-21"-12"																																
	39"	6"-18"-6"	57"	12"-24"-12"																																
	42"	9"-15"-9"	60"	12"-27"-12"																																
	45"	9"-18"-9"	63"	12"-30"-12"																																
	48"	9"-21"-9"	66"	15"-27"-15"																																
	51"	9"-24"-9"	69"	15"-30"-15"																																
		72"	15"-33"-15"																																	
	9	2	VSDD(8)63x34.5																																	
	9	2	VSDD(8)66x34.5																																	
	9	2	VSDD(8)69x34.5																																	
	9	2	VSDD(8)72x34.5																																	
NOTE: Modify drawer opening height using modification – DWR OP HT D1-D4 (10%) Modify drawer height using modification – DWR HT D1-D4(10%)																																				

Vanities

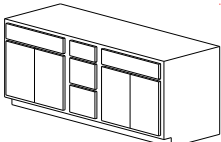
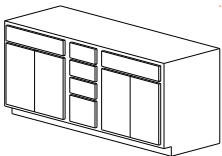
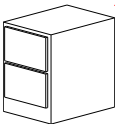

Simplicity
Face Frame

Cabinets are 32" high by 21" deep unless specified. Model number indicates width. Special height is shown by stating number of inches after width. Special depth is specified after width or height by a dash and the number of inches deep.		DRAWERS	DOORS													
	VANITY TWO SINK DRAWER(3) 32", 34.5" HIGH															
	No shelves. Cabinet has two false fronts. 32" high cabinet: One small drawer opening height is 4.875" Two large drawer opening heights are 8.3125". 34.5" high Cabinet: One small drawer opening height is 4.875". Two large drawer opening heights are 9.5625".	5	4	VTSD(3)60x32, 34.5												
		5	4	VTSD(3)63x32, 34.5												
		5	4	VTSD(3)66x32, 34.5												
		5	4	VTSD(3)69x32, 34.5												
		5	4	VTSD(3)72x32, 34.5												
	<table border="0"> <thead> <tr> <th>CABINET WIDTH</th> <th>OPENING WIDTHS</th> </tr> </thead> <tbody> <tr> <td>60"</td> <td>21"-9"-21"</td> </tr> <tr> <td>63"</td> <td>21"-12"-21"</td> </tr> <tr> <td>66"</td> <td>21"-15"-21"</td> </tr> <tr> <td>69"</td> <td>24"-12"-24"</td> </tr> <tr> <td>72"</td> <td>24"-15"-24"</td> </tr> </tbody> </table> NOTE: Modify drawer opening height using modification – DWR OP HT D1-D3 (10%) Modify drawer height using modification – DWR HT D1-D3(10%)	CABINET WIDTH	OPENING WIDTHS	60"	21"-9"-21"	63"	21"-12"-21"	66"	21"-15"-21"	69"	24"-12"-24"	72"	24"-15"-24"			
CABINET WIDTH	OPENING WIDTHS															
60"	21"-9"-21"															
63"	21"-12"-21"															
66"	21"-15"-21"															
69"	24"-12"-24"															
72"	24"-15"-24"															
	VANITY TWO SINK DRAWER(4) 34.5" HIGH															
	No shelves. Cabinet has two false fronts. Three small drawer opening heights are 4.875". One large drawer opening height is 7.875".	6	4	VTSD(4)60x34.5												
		6	4	VTSD(4)63x34.5												
		6	4	VTSD(4)66x34.5												
		6	4	VTSD(4)69x34.5												
		6	4	VTSD(4)72x34.5												
	<table border="0"> <thead> <tr> <th>CABINET WIDTH</th> <th>OPENING WIDTHS</th> </tr> </thead> <tbody> <tr> <td>60"</td> <td>21"-9"-21"</td> </tr> <tr> <td>63"</td> <td>21"-12"-21"</td> </tr> <tr> <td>66"</td> <td>21"-15"-21"</td> </tr> <tr> <td>69"</td> <td>24"-12"-24"</td> </tr> <tr> <td>72"</td> <td>24"-15"-24"</td> </tr> </tbody> </table> NOTE: Modify drawer opening height using modification – DWR OP HT D1-D4 (10%) Modify drawer height using modification – DWR HT D1-D4(10%)	CABINET WIDTH	OPENING WIDTHS	60"	21"-9"-21"	63"	21"-12"-21"	66"	21"-15"-21"	69"	24"-12"-24"	72"	24"-15"-24"			
CABINET WIDTH	OPENING WIDTHS															
60"	21"-9"-21"															
63"	21"-12"-21"															
66"	21"-15"-21"															
69"	24"-12"-24"															
72"	24"-15"-24"															
	VANITY HANGING FILE RACK (2)															
	Two drawer opening heights are 11.5". Drawers include hanging file rack and heavy duty, undermount drawer slides.	2		VHFR(2)12												
		2		VHFR(2)15												
		2		VHFR(2)18												
	Lateral filing is standard in all cabinets except 18", 19.5 or 21" wide.	2		VHFR(2)21												
	Lateral file cabinets 21" or 24" deep will be prep for both Letter and Legal size files.	2		VHFR(2)24												
	Lateral file cabinets 18" deep will be prep for Letter size files.	2		VHFR(2)27												
		2		VHFR(2)30												
		2		VHFR(2)33												
		2		VHFR(2)36												
Cabinets 21" and 19.5" wide will be prep for both Letter and Legal size files.																
Cabinets 18" wide will be prep for Letter size files. Specify for changing to lateral filing (LAT).			LAT													
NOTE: Modify drawer opening height using modification – DWR OP HT D1-D2 (10%) Modify drawer height using modification – DWR HT D1-D2(10%)																

Vanities

Cabinets are 32" high by 21" deep unless specified. Model number indicates width. Special height is shown by stating number of inches after width. Special depth is specified after width or height by a dash and the number of inches deep.		DRAWERS	DOORS	
	VANITY BOTTOM MOUNT HAMPER BASKET FULL DOOR 32", 34.5" HIGH Designed for 18" wide vanity full door cabinet. A single 1.7 bushel white polymer hamper rests in a maple frame with a natural finish and glides on full-extension with 1 1/2" over-travel, ball bearing, 150 lb concealed slides with Rev-A-Motion. VFD(BHB) comes complete with matching lid. Unit Measures: 14 1/4" w x 19 3/4" d x 21" h		1	VFD(BHB)18x32
	VANITY PULL-OUT GROOMING ORGANIZER 32" HIGH Fits in standard Vanity Full Door cabinet with 9" door opening (12" cabinet) and a minimum cabinet depth of 21". Grooming Organizer comes with one adjustable shelf and two stainless steel bins for storing curling irons and hair dryers. The adjustable shelves feature non-skid vinyl liners and clear polycarbonate rails. Organizer has full extension slides. Overall size is 8" w x 20 1/4" h x 19" d.		1	VFD(PGO)12x32
	VANITY PULL-OUT GROOMING ORGANIZER, TALL 34.5" HIGH Fits in standard 34.5"h Vanity Full Door cabinet with 9" door opening (12" cabinet) and a minimum cabinet depth of 21". Tall Grooming Organizer comes with two adjustable shelves and two stainless steel bins for storing curling irons and hair dryers. The adjustable shelves feature non-skid vinyl liners and clear polycarbonate rails. Organizer has full extension slides. Overall size is 8" w x 25.5" h x 19" d.		1	VFD(PGOT)12x34.5

Vanities

Cabinets are 32" high by 21" deep unless specified. Model number indicates width. Special height is shown by stating number of inches after width. Special depth is specified after width or height by a dash and the number of inches deep.		DRAWERS	DOORS	
	VANITY PULL-OUT ORGANIZER 32", 34.5" HIGH			
	Fits in standard Vanity Full Door cabinet with 9" door opening (12" cabinet) and a minimum cabinet depth of 21". Organizer comes with two adjustable shelves. The adjustable shelves feature non-skid vinyl liners and clear polycarbonate storage trays. Organizer has full extension slides. Overall size is 8" w x 20.25" h x 19" d.		1	VFD(PO)12x32
	VANITY PULL-OUT ORGANIZER, TALL 32", 34.5" HIGH			
	Fits in standard 34.5" high Vanity Full Door cabinet with 9" door opening (12" cabinet) and a minimum cabinet depth of 21". Tall organizer comes with three adjustable shelves. The adjustable shelves feature non-skid vinyl liners and clear polycarbonate storage trays. Organizer has full extension slides. Overall size is 8" w x 25.5" h x 19" d.		1	VFD(POT)12x34.5

Talls

Simplicity
Face Frame



Talls

Talls

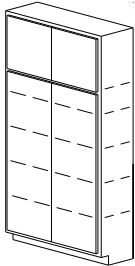
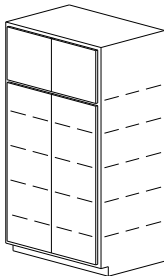
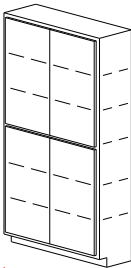

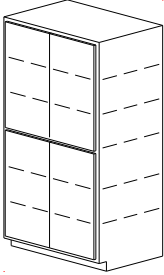
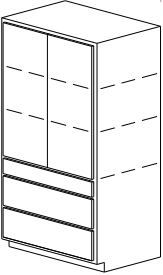
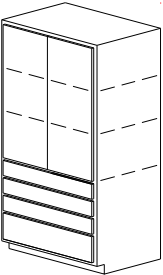
Cabinets are 84" high by 24" deep unless specified. Model number indicates width. Special height is shown by stating number of inches after width. Special depth is specified after width or height by a dash and the number of inches deep.		DRAWERS	DOORS	
	TALL UTILITY 84", 96", 120" HIGH - 12" DEEP			
	Lower door opening height is 58". Cabinets 39" thru 48" wide have a 3" wide center stile.		2	TU12x84, 96, 120-12
			2	TU15x84, 96, 120-12
			2	TU18x84, 96, 120-12
	84" high cabinet: 4 adjustable shelves		2	TU21x84, 96, 120-12
	96" high cabinet: 5 adjustable shelves		2	TU24x84, 96, 120-12
	120" high cabinet: 6 adjustable shelves		4	TU27x84, 96, 120-12
			4	TU30x84, 96, 120-12
			4	TU33x84, 96, 120-12
			4	TU36x84, 96, 120-12
		4	TU39x84, 96, 120-12	
		4	TU42x84, 96, 120-12	
		4	TU45x84, 96, 120-12	
		4	TU48x84, 96, 120-12	
	TALL UTILITY 84", 96", 120" HIGH			
	Lower door opening height is 58". Cabinets 39" thru 48" wide have a 3" wide center stile.		2	TU12x84, 96, 120
			2	TU15x84, 96, 120
			2	TU18x84, 96, 120
	84" high cabinet: 4 adjustable shelves		2	TU21x84, 96, 120
	96" high cabinet: 5 adjustable shelves		2	TU24x84, 96, 120
	120" high cabinet: 6 adjustable shelves		4	TU27x84, 96, 120
			4	TU30x84, 96, 120
			4	TU33x84, 96, 120
			4	TU36x84, 96, 120
		4	TU39x84, 96, 120	
		4	TU42x84, 96, 120	
		4	TU45x84, 96, 120	
		4	TU48x84, 96, 120	
	TALL LINEN 84", 96", 120" HIGH - 12" DEEP			
	Two equal openings. Cabinets 39" thru 48" wide have a 3" center stile.		2	TL12x84, 96, 120-12
			2	TL15x84, 96, 120-12
			2	TL18x84, 96, 120-12
	84" high cabinet: 4 adjustable shelves		2	TL21x84, 96, 120-12
	96" high cabinet: 5 adjustable shelves		2	TL24x84, 96, 120-12
	120" high cabinet: 6 adjustable shelves		4	TL27x84, 96, 120-12
			4	TL30x84, 96, 120-12
			4	TL33x84, 96, 120-12
			4	TL36x84, 96, 120-12
		4	TL39x84, 96, 120-12	
		4	TL42x84, 96, 120-12	
		4	TL45x84, 96, 120-12	
		4	TL48x84, 96, 120-12	

Cabinets are 84" high by 24" deep unless specified. Model number indicates width. Special height is shown by stating number of inches after width. Special depth is specified after width or height by a dash and the number of inches deep.		DRAWERS	DOORS	
 <p>TALL LINEN 84", 96", 120" HIGH</p> <p>Two equal openings.</p> <p>Cabinets 39" thru 48" wide have a 3" center stile.</p> <p>84" high cabinet: 4 adjustable shelves</p> <p>96" high cabinet: 5 adjustable shelves</p> <p>120" high cabinet: 6 adjustable shelves</p> <p>NOTE: Modify bottom opening height using modification – BOT OP HT (10%)</p>	<p>TALL LINEN 84", 96", 120" HIGH</p>			
	<p>Two equal openings.</p> <p>Cabinets 39" thru 48" wide have a 3" center stile.</p> <p>84" high cabinet: 4 adjustable shelves</p> <p>96" high cabinet: 5 adjustable shelves</p> <p>120" high cabinet: 6 adjustable shelves</p> <p>NOTE: Modify bottom opening height using modification – BOT OP HT (10%)</p>		2	TL12x84, 96, 120
			2	TL15x84, 96, 120
			2	TL18x84, 96, 120
			2	TL21x84, 96, 120
			2	TL24x84, 96, 120
			4	TL27x84, 96, 120
			4	TL30x84, 96, 120
			4	TL33x84, 96, 120
			4	TL36x84, 96, 120
		4	TL39x84, 96, 120	
		4	TL42x84, 96, 120	
		4	TL45x84, 96, 120	
		4	TL48x84, 96, 120	
 <p>TALL LINEN DRAWER (3) 84", 96", 120" HIGH</p> <p>One small drawer opening height is 4.875" and two large drawer opening heights are 8.3125". These are the same heights as a three drawer vanity cabinet.</p> <p>Cabinets 39" thru 48" wide have a 3" center stile.</p> <p>84" high cabinet: 2 adjustable shelves</p> <p>96" high cabinet: 3 adjustable shelves</p> <p>120" high cabinet: 4 adjustable shelves</p> <p>NOTE: Modify drawer opening height using modification – DWR OP HT D1-D3 (10%) Modify drawer height using modification – DWR HT D1-D3(10%)</p>	<p>TALL LINEN DRAWER (3) 84", 96", 120" HIGH</p>			
	<p>One small drawer opening height is 4.875" and two large drawer opening heights are 8.3125". These are the same heights as a three drawer vanity cabinet.</p> <p>Cabinets 39" thru 48" wide have a 3" center stile.</p> <p>84" high cabinet: 2 adjustable shelves</p> <p>96" high cabinet: 3 adjustable shelves</p> <p>120" high cabinet: 4 adjustable shelves</p> <p>NOTE: Modify drawer opening height using modification – DWR OP HT D1-D3 (10%) Modify drawer height using modification – DWR HT D1-D3(10%)</p>	3	1	TLD(3)12x84, 96, 120
		3	1	TLD(3)15x84, 96, 120
		3	1	TLD(3)18x84, 96, 120
		3	1	TLD(3)21x84, 96, 120
		3	1	TLD(3)24x84, 96, 120
		3	2	TLD(3)27x84, 96, 120
		3	2	TLD(3)30x84, 96, 120
		3	2	TLD(3)33x84, 96, 120
		3	2	TLD(3)36x84, 96, 120
		3	2	TLD(3)39x84, 96, 120
		3	2	TLD(3)42x84, 96, 120
		3	2	TLD(3)45x84, 96, 120
	3	2	TLD(3)48x84, 96, 120	
 <p>TALL LINEN DRAWER (4) 84", 96", 120" HIGH</p> <p>Three small drawer opening heights 4 7/8" and one large drawer opening height 7 7/8". These are the same heights as a four drawer base cabinet.</p> <p>Cabinets 39" thru 48" wide have a 3" center stile.</p> <p>84" high cabinet: 2 adjustable shelves</p> <p>96" high cabinet: 3 adjustable shelves</p> <p>120" high cabinet: 4 adjustable shelves</p> <p>NOTE: Modify drawer opening height using modification – DWR OP HT D1-D4 (10%) Modify drawer height using modification – DWR HT D1-D4(10%)</p>	<p>TALL LINEN DRAWER (4) 84", 96", 120" HIGH</p>			
	<p>Three small drawer opening heights 4 7/8" and one large drawer opening height 7 7/8". These are the same heights as a four drawer base cabinet.</p> <p>Cabinets 39" thru 48" wide have a 3" center stile.</p> <p>84" high cabinet: 2 adjustable shelves</p> <p>96" high cabinet: 3 adjustable shelves</p> <p>120" high cabinet: 4 adjustable shelves</p> <p>NOTE: Modify drawer opening height using modification – DWR OP HT D1-D4 (10%) Modify drawer height using modification – DWR HT D1-D4(10%)</p>	4	1	TLD(4)12x84, 96, 120
		4	1	TLD(4)15x84, 96, 120
		4	1	TLD(4)18x84, 96, 120
		4	1	TLD(3)21x84, 96, 120
		4	1	TLD(4)24x84, 96, 120
		4	2	TLD(4)27x84, 96, 120
		4	2	TLD(4)30x84, 96, 120
		4	2	TLD(4)33x84, 96, 120
		4	2	TLD(4)36x84, 96, 120
		4	2	TLD(4)39x84, 96, 120
		4	2	TLD(4)42x84, 96, 120
		4	2	TLD(4)45x84, 96, 120
	4	2	TLD(4)48x84, 96, 120	

Talls

Simplicity
Face Frame

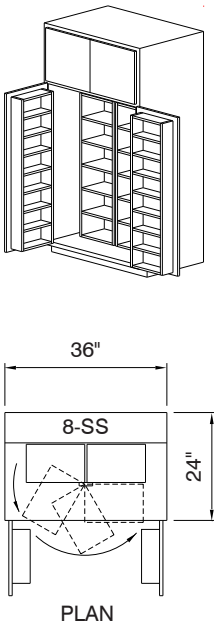
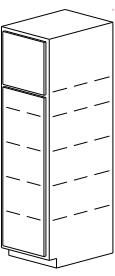
Talls

Cabinets are 84" high by 24" deep unless specified. Model number indicates width. Special height is shown by stating number of inches after width. Special depth is specified after width or height by a dash and the number of inches deep.		DRAWERS	DOORS	
 <p>TALL PANTRY 84", 96", 120" HIGH</p> <p>Top opening: 1 adjustable shelf</p> <p>Bottom opening: Two door storage units with six adjustable shelves with chrome rails each. Door Unit is 12" wide by 51" high by 4" deep. Natural wood finish only.</p> <p>Two swing-out center units with six adjustable shelves with chrome rails each. Swing Out Unit is 12"w x 51"h - 7 1/2"d Natural wood finish only.</p> <p>Eight adjustable back shelves (8 SS) 10" deep.</p> <p>TP will function only with doors open a minimum of 90°. Storage units are designed for a 36" wide by 24" deep cabinet only.</p>				
		4	TP36x84, 96, 120	
 <p>TALL CHEF'S PULL-OUT PANTRY CHROME 84", 96", 120" HIGH</p> <p>Top opening: 1 adjustable shelf</p> <p>Bottom opening: Four adjustable, center mounted, baskets with non-slip maple melamine bottom and a chrome fence rail on a pull-out frame. Pantry is adjustable in height from 47 1/4" to 63".</p> <p>12" wide cabinet has (4) 10" w x 20 3/8" d x 4 1/8" h baskets. 15" wide cabinet has (4) 13" w x 20 3/8" d x 4 1/8" h baskets. 18" wide cabinet has (4) 16" w x 20 3/8" d x 4 1/8" h baskets. 21" wide cabinet has (4) 19" w x 20 3/8" d x 4 1/8" h baskets. 24" wide cabinet has (4) 22" w x 20 3/8" d x 4 1/8" h baskets.</p> <p>Designed for 24" deep cabinets only.</p> <p>CAUTION: Using TCPP next to wall restricts access on wall side.</p> <p>NOTE: Modify bottom opening height using modification – BOT OP HT (10%)</p>				
		2 2 2 2 2	T(CPP-CHR)12x84, 96, 120 T(CPP-CHR)15x84, 96, 120 T(CPP-CHR)18x84, 96, 120 T(CPP-CHR)21x84, 96, 120 T(CPP-CHR)24x84, 96, 120	
				

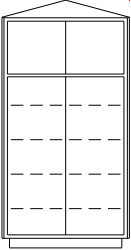
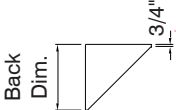
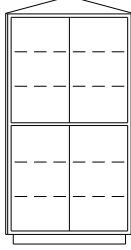
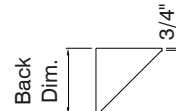
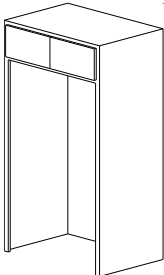
Cabinets are 84" high by 24" deep unless specified. Model number indicates width. Special height is shown by stating number of inches after width. Special depth is specified after width or height by a dash and the number of inches deep.		DRAWERS	DOORS									
 	<p>TALL CORNER UTILITY 84", 96", 120" HIGH</p>											
	<p>Cabinet back dimension is 18", 21", or 24". Finished end panels not available.</p> <p>Lower door opening height is 58".</p> <table border="0"> <tr> <td>Cabinet Back Dimension</td> <td>Cabinet Door Opening Width</td> </tr> <tr> <td>18" x 18"</td> <td>20 7/8"</td> </tr> <tr> <td>21" x 21"</td> <td>25 1/8"</td> </tr> <tr> <td>24" x 24"</td> <td>29 3/8"</td> </tr> </table> <p>84" high cabinet: 4 adjustable shelves</p> <p>96" high cabinet: 5 adjustable shelves</p> <p>120" high cabinet: 6 adjustable shelves</p> <p>NOTE: Modify bottom opening height using modification – BOT OP HT (10%)</p>	Cabinet Back Dimension	Cabinet Door Opening Width	18" x 18"	20 7/8"	21" x 21"	25 1/8"	24" x 24"	29 3/8"	4	4	TCU18x84, 96, 120
	Cabinet Back Dimension	Cabinet Door Opening Width										
	18" x 18"	20 7/8"										
21" x 21"	25 1/8"											
24" x 24"	29 3/8"											
		4	4	TCU21x84, 96, 120								
		4	4	TCU24x84, 96, 120								
 	<p>TALL CORNER LINEN 84", 96", 120" HIGH</p>											
	<p>Cabinet back dimension is 18", 21", or 24". Finished end panels not available.</p> <p>Two equal openings.</p> <table border="0"> <tr> <td>Cabinet Back Dimension</td> <td>Cabinet Door Opening Width</td> </tr> <tr> <td>18" x 18"</td> <td>20 7/8"</td> </tr> <tr> <td>21" x 21"</td> <td>25 1/8"</td> </tr> <tr> <td>24" x 24"</td> <td>29 3/8"</td> </tr> </table> <p>84" high cabinet: 4 adjustable shelves</p> <p>96" high cabinet: 5 adjustable shelves</p> <p>120" high cabinet: 6 adjustable shelves</p> <p>NOTE: Modify bottom opening height using modification – BOT OP HT (10%)</p>	Cabinet Back Dimension	Cabinet Door Opening Width	18" x 18"	20 7/8"	21" x 21"	25 1/8"	24" x 24"	29 3/8"	4	4	TCL18x84, 96, 120
	Cabinet Back Dimension	Cabinet Door Opening Width										
	18" x 18"	20 7/8"										
21" x 21"	25 1/8"											
24" x 24"	29 3/8"											
		4	4	TCL21x84, 96, 120								
		4	4	TCL24x84, 96, 120								
	<p>TALL REFRIGERATOR 84", 96", 120" HIGH</p>											
	<p>Opening clearance is 3" less than cabinet width by 70" high, but can be changed to fit refrigerator. Cabinet interior has same wood and finish as exterior. Cabinet has a 3" wide center stile between doors.</p> <p>Bottom opening is variable. Cabinet has a full back.</p> <p>84" high cabinet: Door opening height is 11".</p> <p>96" high cabinet: Door opening height is 23".</p> <p>120" high cabinet: Door opening height is 47".</p>	2	2	TR39x84, 96, 120								
			2	2	TR42x84, 96, 120							

Talls

Talls

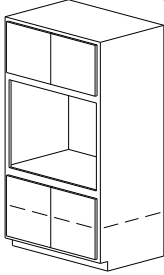
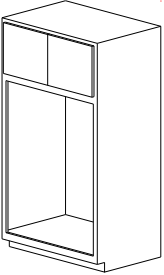
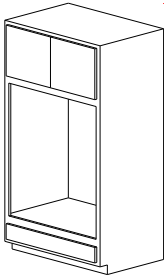
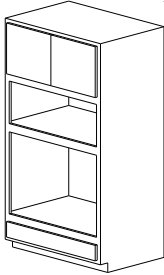
		DRAWERS	DOORS	
<p>Cabinets are 84" high by 24" deep unless specified. Model number indicates width. Special height is shown by stating number of inches after width. Special depth is specified after width or height by a dash and the number of inches deep.</p>				
	<p>TALL OVEN, 1 OR 2 CUT-OUTS 84", 96" HIGH</p>			
	<p>Specify cut-out size. Maximum cut-out width is 2" less than cabinet width.</p>		4	TO(CO1) 27x84, 96, 120
			4	TO(CO1) 30x84, 96, 120
			4	TO(CO1) 33x84, 96, 120
	<p>84" high cabinet: Upper door opening height varies due to cut-out size, no shelves. Lower door opening height is 24", 1 shelf.</p>		4	TO(CO1) 36x84, 96, 120
	<p>96" high cabinet: Upper door opening height varies due to cut-out size, 2 shelves. Lower door opening height is 24", 1 shelf.</p>		4	TO(CO2) 27x84, 96, 120
		4	TO(CO2) 30x84, 96, 120	
		4	TO(CO2) 33x84, 96, 120	
		4	TO(CO2) 36x84, 96, 120	
	<p>NOTE: Modify bottom opening height using modification – BOT OP HT (10%)</p>			
	<p>TALL OVEN, 3 CUT-OUTS 84", 96" HIGH</p>			
	<p>Specify cut-out size. Maximum cut-out width is 2" less than cabinet width.</p>		2	TO(CO3) 27x84, 96, 120
			2	TO(CO3) 30x84, 96, 120
			2	TO(CO3) 33x84, 96, 120
	<p>84" high cabinet: Upper door opening height varies 17", no shelves.</p>		2	TO(CO3) 36x84, 96, 120
	<p>96" high cabinet: Upper door opening height varies 29", two shelves.</p>			
 	<p>TALL OVEN DRAWER, 1 OR 2 CUT-OUTS 84", 96" HIGH</p>			
	<p>Specify cut-out size or sizes. Maximum cut-out width is 2" less than cabinet width.</p>	1	2	TOD(CO1) 27x84, 96, 120
		1	2	TOD(CO1) 30x84, 96, 120
		1	2	TOD(CO1) 33x84, 96, 120
	<p>Single cut-out height or double cut-out height with 3" center rail must not exceed 50.5" to allow for a minimum drawer opening height of 3".</p>	1	2	TOD(CO1) 36x84, 96, 120
	<p>84" high cabinet: Upper door opening height varies due to cut-out size, no shelves. Drawer opening height is 4.875".</p>	1	2	TOD(CO2) 27x84, 96, 120
		1	2	TOD(CO2) 30x84, 96, 120
		1	2	TOD(CO2) 33x84, 96, 120
		1	2	TOD(CO2) 36x84, 96, 120
	<p>96" high cabinet: Upper door opening height varies due to cut-out size, 2 shelves. Drawer opening height is 4.875".</p>			
	<p>NOTE: Modify drawer opening height using modification – DWR OP HT (10%) Modify drawer height using modification – DWR HT (10%)</p>			

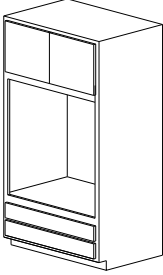
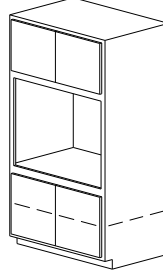
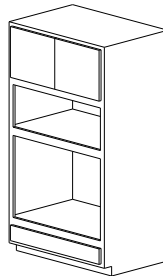
Cabinets are 84" high by 24" deep unless specified. Model number indicates width. Special height is shown by stating number of inches after width. Special depth is specified after width or height by a dash and the number of inches deep.		DRAWERS	DOORS		
	TALL OVEN DRAWER (2), 1 OR 2 CUT-OUTS 84", 96" HIGH				
	Specify cut-out size or sizes. Maximum cut-out width is 2" less than cabinet width. Single cut-out height or double cut-out height with 3" center rail must not exceed 46" to allow for two minimum drawer opening heights of 3". 84" high cabinet: Upper door opening height varies due to cut-out size, no shelves. Two equal drawer opening heights 4.875". 96" high cabinet: Upper door opening height varies due to cut-out size, 2 shelves. Two equal drawer opening heights 4.875". NOTE: Modify drawer opening height using modification – DWR OP HT D1-D2 (10%) Modify drawer height using modification – DWR HT D1-D2(10%)	2 2 2 2	2 2 2 2	TOD(2)(CO1) 27x84, 96, 120 TOD(2)(CO1) 30x84, 96, 120 TOD(2)(CO1) 33x84, 96, 120 TOD(2)(CO1) 36x84, 96, 120	
	84" high cabinet: Upper door opening height varies due to cut-out size, no shelves. Two equal drawer opening heights 4.875". 96" high cabinet: Upper door opening height varies due to cut-out size, 2 shelves. Two equal drawer opening heights 4.875". NOTE: Modify drawer opening height using modification – DWR OP HT D1-D2 (10%) Modify drawer height using modification – DWR HT D1-D2(10%)	2 2 2 2	2 2 2 2	TOD(2)(CO2) 27x84, 96, 120 TOD(2)(CO2) 30x84, 96, 120 TOD(2)(CO2) 33x84, 96, 120 TOD(2)(CO2) 36x84, 96, 120	
	TALL OVEN-OPEN SHELF 84", 96" HIGH				
	Open shelf width is 3" less than cabinet width by specified height. Cabinet interior has same wood and finish as exterior. 84" high cabinet: Upper door opening height varies due to open shelf size 17", no shelves. Open shelf height varies Lower door opening height is 36", 2 shelves 96" high cabinet: Upper door opening height varies due to open shelf size 29", 2 shelves. Open shelf height varies Lower door opening height is 36", 2 shelves NOTE: Modify bottom opening height using modification –		3 3 3 3	TO-OS 27x84, 96, 120 TO-OS 30x84, 96, 120 TO-OS 33x84, 96, 120 TO-OS 36x84, 96, 120	
	TALL OVEN DRAWER-OPEN SHELF, 1 CUT-OUT 84", 96" HIGH				
	Specify cut-out size. Maximum cut-out width is 2" less than cabinet width. Open shelf width is 3" less than cabinet width by specified height. Cabinet interior has same wood and finish as exterior. 84" high cabinet: Upper door opening height varies due to cut-out and open shelf size, no shelves. Open shelf height varies Drawer opening height is 4.875". 96" high cabinet: Upper door opening height varies due to cut-out and open shelf size, 2 shelves. Open shelf height varies Drawer opening height is 4.875". NOTE: Modify drawer opening height using modification – DWR OP HT (10%) Modify drawer height using modification – DWR HT (10%)	1 1 1 1	3 3 3 3	TOD-OS(CO1) 27x84, 96, 120 TOD-OS(CO1) 30x84, 96, 120 TOD-OS(CO1) 33x84, 96, 120 TOD-OS(CO1) 36x84, 96, 120	

Talls

Talls

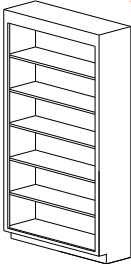
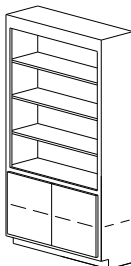
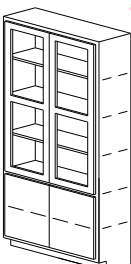
Cabinets are 84" high by 24" deep unless specified. Model number indicates width. Special height is shown by stating number of inches after width. Special depth is specified after width or height by a dash and the number of inches deep.		DRAWERS	DOORS	
 <p>TALL BOOKCASE 84", 96", 120" HIGH, 12" DEEP</p> <p>Cabinet interior has same finish as exterior.</p> <p>84" high cabinet: 5 adjustable shelves</p> <p>96" high cabinet: 6 adjustable shelves</p> <p>120" high cabinet: 8 adjustable shelves</p> <p>MODIFICATIONS: VAL (Style): Cabinet standard with straight valance C. Optional valance styles are available. HS-SWM: Shelves with edge mold are available and recommended on wide cabinets.</p>				
				TB12x84, 96, 120 TB15x84, 96, 120 TB18x84, 96, 120
				TB21x84, 96, 120 TB24x84, 96, 120 TB27x84, 96, 120
				TB30x84, 96, 120 TB33x84, 96, 120 TB36x84, 96, 120
				VAL (Style) HS-SWM NO VAL
 <p>TALL BOOKCASE EXEC 84", 96", 120" HIGH, 12" DEEP</p> <p>Cabinet interior has same finish as exterior. Door opening height is 21".</p> <p>84" high cabinet: 4 adjustable shelves</p> <p>96" high cabinet: 5 adjustable shelves</p> <p>120" high cabinet: 7 adjustable shelves</p> <p>MODIFICATIONS: VAL (Style): Cabinet standard with straight valance C. Optional valance styles are available. HS-SWM: Shelves with edge mold are available and recommended on wide cabinets. NOTE: Modify bottom opening height using modification – BOT OP HT (10%)</p>				
		1		TBE12x84, 96, 120
		1		TBE15x84, 96, 120
		1		TBE18x84, 96, 120
		1		TBE21x84, 96, 120
		1		TBE24x84, 96, 120
	2		TBE27x84, 96, 120	
	2		TBE30x84, 96, 120	
	2		TBE33x84, 96, 120	
	2		TBE36x84, 96, 120	
			VAL (Style) HS-SWM NO VAL	
 <p>TALL HUTCH 84", 96", 120" HIGH, 12" DEEP</p> <p>Cabinet interior has same finish as exterior. Lower door opening height is 21". Upper doors are prep for glass (glass not furnished).</p> <p>84" high cabinet: Upper door opening height is 54", 4 adjustable shelves</p> <p>96" high cabinet: Upper door opening height is 66", 5 adjustable shelves</p> <p>120" high cabinet: Upper door opening height is 90", 7 adjustable shelves</p> <p>MODIFICATIONS: NCR: Select upper doors are standard with a center rail. Specify for no center rail. HS-SWM: Shelves with edge mold are available and recommended on wide cabinets. NOTE: Modify bottom opening height using modification – BOT OP HT (10%)</p>				
		2		TH12x84, 96, 120
		2		TH15x84, 96, 120
		2		TH18x84, 96, 120
		2		TH21x84, 96, 120
		2		TH24x84, 96, 120
		4		TH27x84, 96, 120
		4		TH30x84, 96, 120
		4		TH33x84, 96, 120
		4		TH36x84, 96, 120
				NCR HS-SWM

A black and white photograph of a kitchen. In the foreground, a white cabinet with three drawers is visible. The drawers have simple, rectangular handles. Above the cabinet, a window with a dark frame holds a white vase filled with a bouquet of flowers. To the right of the window, a decorative tile backsplash with a repeating geometric pattern is visible. The overall scene is bright and clean.

Simplicity
Face Frame

Modifications

Modifications

Modifications

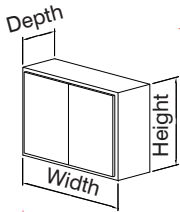
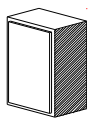
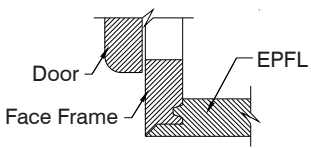
	SPECIAL SIZES								
	<p>Special sizes are available. Indicate size in cabinet nomenclature. On special height base, the drawer front height will remain same and only door height will change unless specified.</p> <p>Cabinet with drawer has a minimum 9" width, maximum 36" width, and minimum 12" depth. Cabinet greater than 24" deep will still have a standard depth drawer for a 24" deep cabinet.</p> <p>Wall - Max. size 48" wide, 72" high, 30" deep. Base and Vanity - Max. size 48" wide, 60" high, 24" deep. Tall - Max. size 48" wide, 120" high, 24" deep.</p>								
 <p>RIGHT HAND SHOWN</p>	FINISHED END PANELS								
	<p>Standard end panels are unfinished. Finished end panels will be same wood and finish as specified on the order.</p>	<table border="1"> <thead> <tr> <th></th> <th style="text-align: right;">PRICE</th> </tr> </thead> <tbody> <tr> <td>FEP-L</td> <td style="text-align: right;">\$34.78</td> </tr> <tr> <td>FEP-R</td> <td style="text-align: right;">\$34.78</td> </tr> <tr> <td>FEB-BOTH</td> <td style="text-align: right;">\$34.78</td> </tr> </tbody> </table>		PRICE	FEP-L	\$34.78	FEP-R	\$34.78	FEB-BOTH
	PRICE								
FEP-L	\$34.78								
FEP-R	\$34.78								
FEB-BOTH	\$34.78								
	FLUSH FINISHED END PANELS								
	<p>Standard end panels are unfinished. Flush Finished End Panels are available by specifying EPFL-LT or EPFL-RT. Not available on angle corner or diagonal corner frames.</p> <p>Finished end panels will be same wood and finish as specified on the order. Finished end panels are flush with no joints. A locking miter joint is used to assemble end panel to the face frame.</p> <div style="text-align: center;">  <p>DETAIL</p> </div>	<table border="1"> <thead> <tr> <th></th> <th style="text-align: right;">Up Charge</th> </tr> </thead> <tbody> <tr> <td>EPFL-LT</td> <td style="text-align: right;">60%</td> </tr> <tr> <td>EPFL-RT</td> <td style="text-align: right;">60%</td> </tr> <tr> <td>EPFL-BOTH</td> <td style="text-align: right;">100%</td> </tr> </tbody> </table>		Up Charge	EPFL-LT	60%	EPFL-RT	60%	EPFL-BOTH
	Up Charge								
EPFL-LT	60%								
EPFL-RT	60%								
EPFL-BOTH	100%								

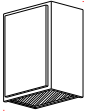
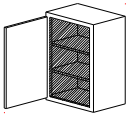
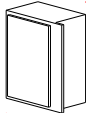
	<p>FINISH BOTTOM PANEL READY FINISH TOP PANEL READY</p> <p>Cabinet bottom or top as indicated will be prepared to receive panel for a flush finished bottom. Unfinished end panels and back will be cut short for application of finished paneling. Finished end panels will be left standard height. Finish Paneling must be ordered separately, specify FINISH PANEL in width and length desired.</p>	<p style="text-align: right;">Up Charge</p> <table border="1"> <tr> <td>FIN BTM READY</td> <td style="text-align: right;">15%</td> </tr> <tr> <td>FIN TOP READY</td> <td style="text-align: right;">15%</td> </tr> <tr> <td>FINISH PANEL w x h</td> <td></td> </tr> <tr> <td></td> <td></td> </tr> <tr> <td></td> <td></td> </tr> <tr> <td></td> <td></td> </tr> </table>	FIN BTM READY	15%	FIN TOP READY	15%	FINISH PANEL w x h									
FIN BTM READY	15%															
FIN TOP READY	15%															
FINISH PANEL w x h																
	<p>FINISHED INTERIOR</p> <p>Cabinet interior is available in same wood and finish as exterior. When specifying finish interior, the wall cabinet bottom will be finished the same as cabinet exterior. Shelving will be the same wood and finish as cabinet exterior. The exception will be wood accessories such as drawers, pullout trays, and spice racks. These items will remain with a natural finish.</p>	<p style="text-align: right;">Up Charge</p> <table border="1"> <tr> <td>FIN INT</td> <td style="text-align: right;">45%</td> </tr> <tr> <td></td> <td></td> </tr> <tr> <td></td> <td></td> </tr> <tr> <td></td> <td></td> </tr> <tr> <td></td> <td></td> </tr> </table>	FIN INT	45%												
FIN INT	45%															
 <p>RIGHT HAND SHOWN</p>	<p>EXTEND STILE</p> <p>Face frame extended stile is available up to 4.5" wide. Extended stile is not available on 48" wide tall cabinets.</p> <p>EXT 3/32" is needed when face frame is attached to an adjacent cabinet end panel.</p> <p>EXT 3/32" is needed next to walls when door is thicker than .75" and modified for Full Overlay.</p>	<p style="text-align: right;">PRICE</p> <table border="1"> <tr> <td>EXT FR LT or RT</td> <td style="text-align: right;">\$110.87</td> </tr> <tr> <td></td> <td></td> </tr> <tr> <td></td> <td></td> </tr> <tr> <td></td> <td></td> </tr> <tr> <td></td> <td></td> </tr> <tr> <td></td> <td></td> </tr> <tr> <td></td> <td></td> </tr> </table>	EXT FR LT or RT	\$110.87												
EXT FR LT or RT	\$110.87															

Modifications

Modifications

Modifications

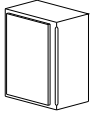
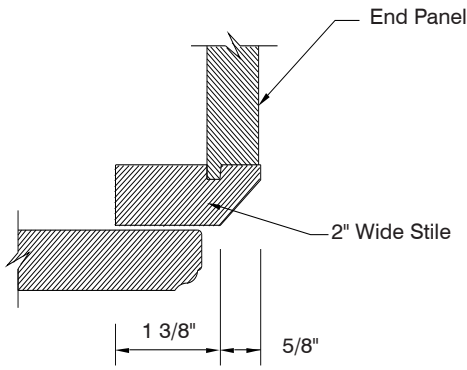
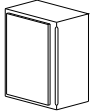
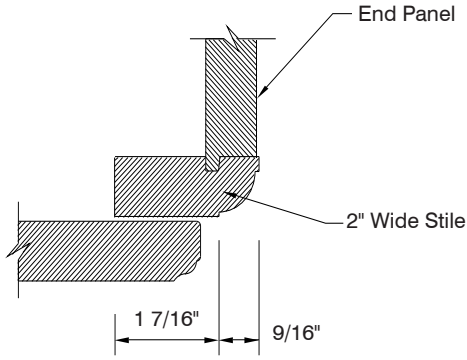
	<p>BEVEL EDGE STILE</p> <p>When ordering beveled edge stile, specify left or right, length of beveled edge, and distance from top of stile. Cabinet face frame stile will change from 1.5" to 2" wide. This modification reduces cabinet opening width by .5" per BE STILE.</p>  <p>Standard End Panel Detail: BE STILE RT Length 29", From Top 1 1/2"</p>	<p style="text-align: right;">Up Charge</p> <p>BE STILE LT or RT 25%</p>
	<p>CURVED EDGE STILE</p> <p>When ordering curved edge stile, specify left or right, length of curved edge, and distance from top of stile. Cabinet face frame stile will change from 1.5" to 2" wide. This modification reduces cabinet opening width by .5" per CE STILE.</p>  <p>Standard End Panel Detail: CE STILE RT Length 29", From Top 1 1/2"</p>	<p style="text-align: right;">Up Charge</p> <p>CE STILE LT or RT 25%</p>

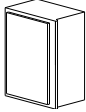
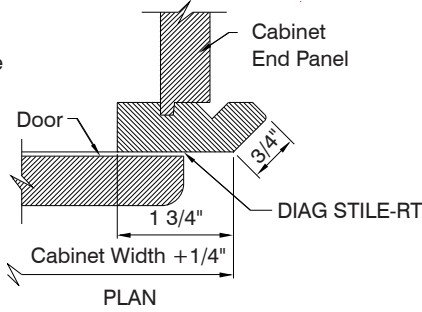
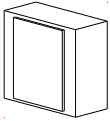
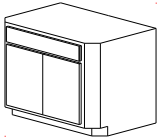
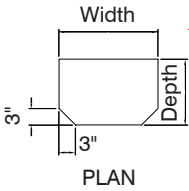
		PRICE
 RIGHT HAND SHOWN	DIAGONAL STILE	
	<p>Diagonal stiles are available on a standard cabinet face frame. Diagonal stile is 1.75" wide, which adds .25" to the cabinet width. Adds .5" to cabinet width when indicating diagonal stiles left and right. Specify left or right.</p> <p>Diagonal stiles are not available on 48" wide tall cabinets.</p> <p>When Overlay Hinge is used, an adjacent cabinet, attached to diagonal stile, requires a .25" extended stile for clearances.</p> 	DIAG STILE LT or RT \$177.39
	WIDE STILE	PRICE
	<p>When ordering wide stile, specify left or right and 3" or 4.5" wide. Wide stile modification reduces cabinet door opening width by 1.5" per WS 3" and 3" per WS 4.5". Wide stile does not add width to cabinet.</p>	WS LT or RT 3" or 4 1/2" \$221.74 PART WS
 	ANGLE CORNER	Up Charge
	<p>When ordering cabinet with angle corner, specify left or right angle corner and 3" wide. Angle corner is 45°. Angle corner does not add width or depth to cabinet unless specified.</p>	AC LT or RT 3" 35%

Modifications

Modifications

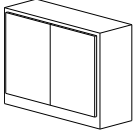
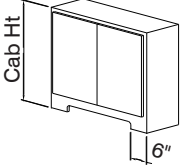
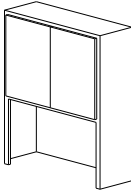
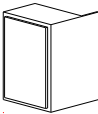
 <p>EXT. DOWN 3" SHOWN</p>	<p>EXTEND CABINET UP OR DOWN</p> <p>Face frame, end panels, and back can be extended up or down a maximum of 3". Available on wall cabinets.</p>	<p style="text-align: right;">PRICE</p> <p>EXT UP or DOWN (3" max.) \$221.74</p>
 <p>VAL B SHOWN</p>	<p>DECORATIVE WALL BOTTOM</p> <p>DEC WBTM is available in same styles as indicated for valances. The wall cabinet will have a 4.5" or 5.5" bottom rail (depending on Valance style chosen). Ends on DEC WBTM can be modified by indicating DEC WBTM END (Dimension). DEC WBTM END does not include 1.5" for face frame stiles. DEC WBTM has a square bottom edge design on straight ends.</p> <p>Cabinet height will remain same as indicated. Door opening height will be reduced by 3" for Valance styles B, C, D, F & H and 4" for styles J & K.</p> <p>Cabinets less than 24" in width may require modified ends.</p>	<p style="text-align: right;">Up Charge</p> <p>DEC WBTM Style 75%</p>
	<p>EXTEND END PANELS DOWN</p> <p>One end panel only can be extended down by specifying left or right. Both end panels and back can be extended down a maximum of 24" by specifying left and right. Cabinet interior should be modified for same wood and finish as exterior so lower open area will be finished.</p> <p>CAUTION: When extending only one end panel down, the back plow remains in the end panel.</p>	<p style="text-align: right;">Up Charge</p> <p>EXT EP DOWN LT or RT (24" max.) \$266.09</p>
 <p>RIGHT HAND SHOWN</p>	<p>EXTEND END PANEL BACK</p> <p>End panel can be extended back a maximum of 12". Specify right or left and the number of inches to extend.</p>	<p style="text-align: right;">PRICE</p> <p>EXT EP BACK LT or RT (12" max.) \$221.74</p>

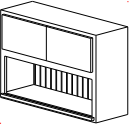
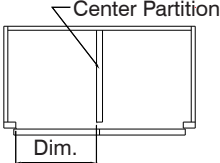
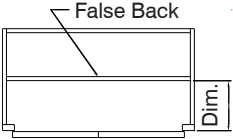
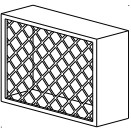
	<p>BEAD PANEL BACK</p> <p>Bead Panel is available on the interior back of cabinets. Specify for BEAD PL BK. Cabinet will automatically be Finished Interior. Available on Oak, Maple, Cherry, Alder, and K Alder.</p>	<p style="text-align: right;">Up Charge</p> <table border="1"> <tr> <td>BEAD PL BK</td> <td style="text-align: right;">60%</td> </tr> <tr><td> </td><td> </td></tr> <tr><td> </td><td> </td></tr> <tr><td> </td><td> </td></tr> </table>	BEAD PL BK	60%								
BEAD PL BK	60%											
 <p style="text-align: center;">PLAN</p>	<p>CENTER PARTITION</p> <p>.75" partitions are available for any standard cabinet. Center partitions are required when specifying for pull-out shelves, pull-out trays or shelving one side in cabinets with two doors. If partition is not centered, locate by indicating clearance from left or right inside edge of cabinet face frame.</p>	<p style="text-align: right;">PRICE</p> <table border="1"> <tr> <td>C</td> <td style="text-align: right;">\$177.39</td> </tr> <tr> <td>CP-LT</td> <td style="text-align: right;">\$86.96</td> </tr> <tr> <td>CP-RT</td> <td style="text-align: right;">\$86.96</td> </tr> <tr><td> </td><td> </td></tr> <tr><td> </td><td> </td></tr> </table>	C	\$177.39	CP-LT	\$86.96	CP-RT	\$86.96				
C	\$177.39											
CP-LT	\$86.96											
CP-RT	\$86.96											
 <p style="text-align: center;">PLAN</p>	<p>FALSE BACK</p> <p>.5" false back is available in any standard cabinet. False back is located by indicating depth from face of cabinet face frame. Specify location of FBK if cabinet has more than one opening.</p>	<p style="text-align: right;">PRICE</p> <table border="1"> <tr> <td>FBK(#)</td> <td style="text-align: right;">\$243.91</td> </tr> <tr><td> </td><td> </td></tr> <tr><td> </td><td> </td></tr> </table>	FBK(#)	\$243.91								
FBK(#)	\$243.91											
	<p>WINE RACK</p> <p>Wine rack has a 4" diamond grid, available on 12" deep cabinets. Cabinet interior will be same wood and finish as exterior.</p>	<p style="text-align: right;">Up Charge</p> <table border="1"> <tr> <td>WR</td> <td style="text-align: right;">70%</td> </tr> <tr><td> </td><td> </td></tr> <tr><td> </td><td> </td></tr> </table>	WR	70%								
WR	70%											

Modifications

Modifications

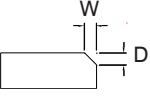
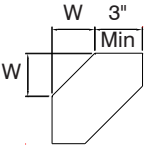
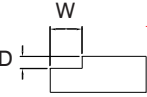
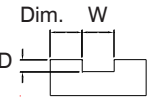
		PRICE
 <p>PLAN</p>	<p>ANGLE BACK</p> <p>Angle back is available on any cabinet without drawers. Specify width and depth of angle. Specify left or right. The cabinet back shall be a minimum of 3" plus angle dimension. The cabinet end panel shall be a minimum of 3" plus angle dimension. Example: AB RT 6" x 6"</p>	<p>AB LT or RT (WxD) \$376.96</p>
 <p>PLAN</p>	<p>ANGLE BACK DIAGONAL</p> <p>Angle back (45°) is available on diagonal cabinets. Specify width of angle. The diagonal cabinet back shall be a minimum of 3" plus width of angle.</p>	<p>Up Charge ABD(W) 25%</p>
 <p>PLAN</p>  <p>PLAN</p>	<p>OFFSET BACK</p> <p>Offset back is available on any cabinet without drawers. Specify width and depth of cut out. Specify left or right plus distance from cabinet end panel (if applicable). Example: OB CTR 12" x 6" x 10" LT</p>	<p>Up Charge OB LT or RT (WxD) 75%</p> <p>OB CTR(WxDx distance from LT or RT end) 75%</p>

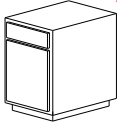
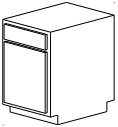
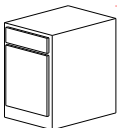
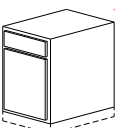
	TOE KICK END PANEL	
	Adds a recessed toe kick to cabinet end panel. Specify left or right end panel.	EXT EP BACK LT or RT (12" max.) PRICE \$266.09
	TOE KICK BACK	TK LT or RT PRICE \$221.74
	Adds a recessed toe kick to back of cabinet.	
		TK BK PRICE \$221.74
	FLUSH TOE KICK	
	Eliminates the recessed toe kick. The cabinet will have a 6" bottom rail which will allow for base mold to be applied for a furniture appearance.	
		FTK PRICE \$155.22
	NO TOE KICK	
	Cabinet Toe Kick height is 4.5". Specify NTK for eliminating toe kick. Specify cabinet height without toe kick. Toe kick blocking (TKB) is available, in 96" lengths, for constructing sub base on jobsite.	
		NTK PRICE \$110.87
		TKB PRICE \$84.26

Modifications

Modifications

Modifications

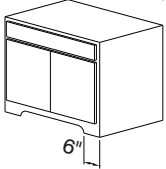
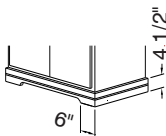
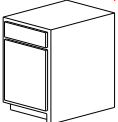
 <p>DEC BASE B SHOWN</p>	<p>DECORATIVE BASE</p> <p>DEC BASE is available in same styles as indicated for valances. The base cabinet will have a 6" bottom rail. Decorative open area is blocked out 3" back from cabinet face frame. DEC BASE has a square bottom edge design.</p> <p>Cabinets less than 24" in width may require modified ends.</p>	<table border="1"> <thead> <tr> <th></th> <th style="text-align: right;">PRICE</th> </tr> </thead> <tbody> <tr> <td>DEC BASE Style</td> <td style="text-align: right;">\$443.48</td> </tr> <tr> <td> </td> <td> </td> </tr> <tr> <td> </td> <td> </td> </tr> <tr> <td> </td> <td> </td> </tr> </tbody> </table>		PRICE	DEC BASE Style	\$443.48						
	PRICE											
DEC BASE Style	\$443.48											
 <p>SUB BASE B SHOWN</p>	<p>SUB BASE</p> <p>SUB BASE is available in same styles D, F, and H as indicated for valances. Cabinet toe kick (4.5" height) is deleted. SUB BASE is 4.5" in height and attached to cabinet base.</p> <p>SUB BASE is 1.125" greater than cabinet width and .5625" greater than cabinet depth. Valance style has a square bottom edge design. SUB BASE design coordinates with Decorative Base Mold (DBM).</p>	<table border="1"> <thead> <tr> <th></th> <th style="text-align: right;">Up Charge</th> </tr> </thead> <tbody> <tr> <td>SUB BASE Style</td> <td style="text-align: right;">50%</td> </tr> <tr> <td> </td> <td> </td> </tr> <tr> <td> </td> <td> </td> </tr> <tr> <td> </td> <td> </td> </tr> </tbody> </table>		Up Charge	SUB BASE Style	50%						
	Up Charge											
SUB BASE Style	50%											
	<p>TOE KICK BLOCK SUPPORT</p> <p>Cabinets 30" wide or over have 3/4" Toe Kick Block Support automatically applied. To change entire order to have Toe Kick Block Support, specify TKBS under cabinet modification in header.</p>	<table border="1"> <thead> <tr> <th></th> <th style="text-align: right;">Up Charge</th> </tr> </thead> <tbody> <tr> <td>TKBS</td> <td style="text-align: right;">3%</td> </tr> <tr> <td> </td> <td> </td> </tr> <tr> <td> </td> <td> </td> </tr> </tbody> </table>		Up Charge	TKBS	3%						
	Up Charge											
TKBS	3%											
 <p>NO EP NOTCH RT SHOWN</p>	<p>NO END PANEL NOTCH</p> <p>NO EP NOTCH eliminates the toe kick notch in the end panel and extends the stile to the floor. Specify left or right end panel.</p> <p>Note: Inside of end panel is not finished</p>	<table border="1"> <thead> <tr> <th></th> <th style="text-align: right;">PRICE</th> </tr> </thead> <tbody> <tr> <td>NO EP NOTCH LT NO EP NOTCH RT</td> <td style="text-align: right;">\$177.39</td> </tr> <tr> <td> </td> <td> </td> </tr> <tr> <td> </td> <td> </td> </tr> </tbody> </table>		PRICE	NO EP NOTCH LT NO EP NOTCH RT	\$177.39						
	PRICE											
NO EP NOTCH LT NO EP NOTCH RT	\$177.39											

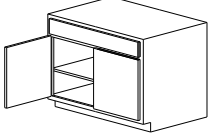
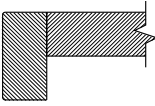
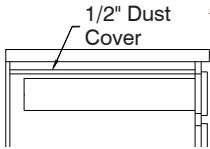
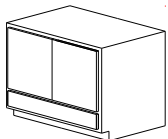
	<p>FULL DEPTH STANDARD SHELF</p> <p>Full depth standard shelving is available for any standard base cabinet. Full depth shelves will not fit in cabinets when the cabinet depth is greater than the door opening height, unless the cabinet has two doors with no center stile.</p>	<p style="text-align: right;">PRICE</p> <p>FDSS \$56.52</p>
 <p>HS-SWM</p>	<p>SHELF MODIFICATION</p> <p>Standard shelving is .75" thick engineered board with finish to match cabinet interior. Optional shelving is available as follows:</p> <p>HS..... Hard Wood Shelf - engineered board with finish to match cabinet exterior.</p> <p>SWS..... Solid Wood Shelf - maximum 16" wide x 96" long.</p> <p>Shelves with Edge Moldings:</p> <p>HS-SWM.....Solid Wood Mold 1.5" plus E6 Profile Top and Bottom.</p> <p>Available Modifications: Edge Band: Shelves are available edgebanded all four sides by specifying EB(4)SIDES.</p>	<p style="text-align: right;">PRICE</p> <p>HS \$69.57 SWS \$69.57 HS-SWM \$86.97</p> <p>EB(4)SIDES 7%UC</p>
 <p>1/2" Dust Cover</p> <p>SIDE VIEW</p>	<p>DUST COVER</p> <p>Full panel dust cover is available in top of base cabinet. Installation of DC is the same as .5" panel top in wall cabinets.</p>	<p style="text-align: right;">Up Charge</p> <p>DC 5%</p>
	<p>INVERTED CABINET</p> <p>Inverted Cabinet modification is available on Base(B) and Vanity(V)cabinets only. Drawer will be at bottom of cabinet with Doors above.</p>	<p style="text-align: right;">PRICE</p> <p>INV \$332.61</p>

Modifications

Modifications

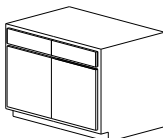
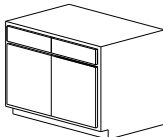
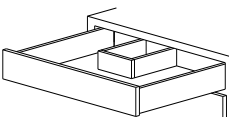
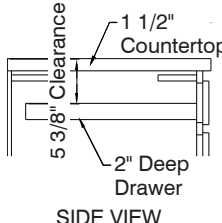
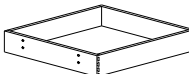
			Up Charge																	
	TWO DRAWERS	DWR 2	30%																	
	<p>Two drawer modification is available on cabinets that are standard with one drawer, 24" thru 36" wide.</p> <p>DWR 2 modification adds center stile between drawers. Drawer front sizes will match door widths.</p>		PRICE																	
	TWO FALSE FRONTS	FF 2	\$199.57																	
	<p>Two false front modification is available on base sink or range cabinets that are standard with one false front, 24" thru 36" wide.</p> <p>FF 2 modification adds center stile between fronts. False front sizes will match door widths.</p>																			
	OFFSET DRAWER		PRICE																	
	<p>U-shaped drawer design created to fit around plumbing in sink cabinets. Check sink specifications and specify width and depth of offset. Offset may not be greater than drawer width minus 8" or drawer depth minus 5".</p>	OFF-DWR	\$332.61																	
 <p>SIDE VIEW</p>	SHALLOW DRAWER		PRICE																	
	<p>A shallow drawer is available in base cabinets to allow 5.375" clearance for installation of thicker or higher cooktops. Clearance from the top of a standard height drawer in a base cabinet is 3.375" when using a 1.5" thick countertop.</p>	S-DWR	\$155.22																	
	DRAWER BOX		Up Charge																	
	<p>Drawer box has .625" solid wood sides, front and back and is slotted to receive .25" plywood bottom, dovetail corners. Includes slides and support brackets as indicated in invoice header information. Drawer box does not include drawer front. Drawer box width is .375" less than opening width. Minimum height opening for a drawer box is .875" greater than the drawer box height.</p> <p>Standard drawer box heights are 2", 4", and 7". Special height drawer boxes are available in 1" increments up to a maximum of 22".</p> <table border="0" style="width: 100%; border-collapse: collapse;"> <thead> <tr> <th style="width: 60%;"></th> <th style="width: 20%; text-align: center;">Cabinet Depth</th> <th style="width: 20%; text-align: center;">Drawer Box Depth</th> </tr> </thead> <tbody> <tr> <td>Indicate cabinet and drawer location when ordering .</td> <td style="text-align: center;">12"</td> <td style="text-align: center;">9"</td> </tr> <tr> <td></td> <td style="text-align: center;">15"</td> <td style="text-align: center;">12"</td> </tr> <tr> <td></td> <td style="text-align: center;">18"</td> <td style="text-align: center;">15"</td> </tr> <tr> <td></td> <td style="text-align: center;">21"</td> <td style="text-align: center;">18"</td> </tr> <tr> <td></td> <td style="text-align: center;">24"</td> <td style="text-align: center;">21"</td> </tr> </tbody> </table>		Cabinet Depth	Drawer Box Depth	Indicate cabinet and drawer location when ordering .	12"	9"		15"	12"		18"	15"		21"	18"		24"	21"	DWRSW
	Cabinet Depth	Drawer Box Depth																		
Indicate cabinet and drawer location when ordering .	12"	9"																		
	15"	12"																		
	18"	15"																		
	21"	18"																		
	24"	21"																		
	TIP-ON TOUCH RELEASE		Up Charge																	
	<p>Tip-On is an opening feature for drawers or inset doors with-out pulls. Doors or drawers can be easily opened with a light touch. Available on drawers in minimum 12" wide cabinet. Drawers will have a full extension tandem glide. Closure control not available.</p>	TIP-ON DRS	10%																	
		TIP-ON DWRS	10%																	
		TIP-ON PT																		

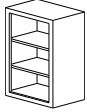
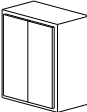
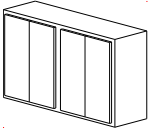
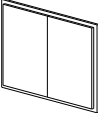
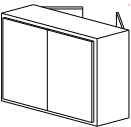
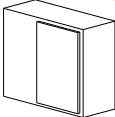
	NO DOORS		PRICE
	No door modification is available on all cabinets. We recommend that cabinet interior should be modified for same wood and finish as exterior. ND modification does not delete center stiles. If needed, see modification for No Center Stile NCS.	ND	-\$86.96
	TWO DOORS		
	Two door modification is available on standard one door cabinet, 24" wide.		Up Charge
		DR 2	20%
	FOUR DOORS		
	Four door modification is available on standard two door cabinets with a center stile, 42", 45", or 48 wide.		Up Charge
		DR 4	20%
 EXAMPLE: W3632 FR&DR	FRAME AND DOORS		
	Frame and doors is available on any cabinet. Indicate if flush toe kick is needed. Always indicate cabinet type.		Up Charge
		FR&DR Cabinet Type and Size EXT FTK	-25%
	PENINSULA		
	Peninsula cabinets have doors on front and back. For a wall diagonal corner cabinet, specify P left back or P right back. Specify hinging, extensions, door modifications, etc., separately for the peninsula side of cabinets. Shelves in base peninsula cabinets are full depth.		Up Charge
		P	30%
		P BK LT or RT Wall Diagonal Corner	100%
 LEFT HAND SHOWN	FLUSH BLIND		
	Flush blind is available on Wall or Base Blind Corner cabinet. Specify for flush blind when cabinet perpendicular to blind is shorter in height. Cabinet blind will be flush and finished.		
		FLUSH BLIND	\$177.39

Modifications

Modifications

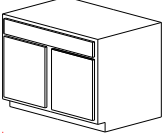
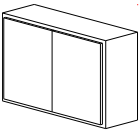
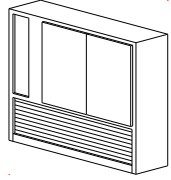
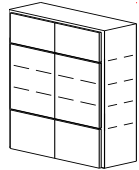
	CENTER STILE - DOOR		
	<p>Center stile modification is available on cabinets 24" thru 36" wide. Use 2 DWR modification if center stile is needed between drawers. Use 2 FF modification if center stile is needed between false fronts.</p>	CS DR	<p style="text-align: right;">PRICE \$199.57</p>
	NO CENTER STILE		
	<p>No center stile modification is available on cabinets 39" thru 42" wide. NCS modification eliminates stile between doors only. Center stile will remain between drawers. Drawer front sizes will match door widths. Caution should be taken because center stile helps support cabinet bottom and shelving. Cabinet without center stile is not guaranteed due to lack of structural support.</p>	NCS	NC
	TAMBOUR MIXER STORAGE ATTACHED		
	<p>Tambour mixer storage is available in combination with other types of cabinets. The TMS is attached to bottom of cabinet and adds 18" to overall height unless specified.</p>	TMS-A	<p style="text-align: right;">PRICE \$665.22</p> <p style="text-align: right;">Up Charge</p>
	MIXER STORAGE ATTACHED	MS-A	45%
	<p>Mixer storage is available in combination with other types of cabinets. The MS is attached to bottom of cabinet and adds 18" to overall height unless specified.</p>		

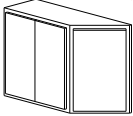
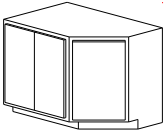
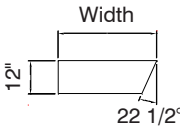
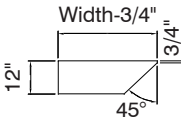
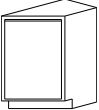
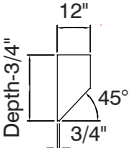
		Up Charge
 <p>RIGHT HAND SHOWN</p>  <p>RIGHT HAND SHOWN</p>	<p>ANGLE DOOR ON END</p> <p>Minimum size cabinet with ADOE is 24" wide by 12" deep. Specify left or right end. Single door hinged toward back.</p> <p>Cabinet 12" deep is available with ADOE 22 1/2°. Angle door opening width is 9.8125". Cabinets 33" thru 48" wide have two doors on front.</p> <p>Cabinets 12" thru 24" deep are available with ADOE 45°. Minimum cabinet width has to be 12" greater than cabinet depth. Angle door opening width on 24" deep cabinet is 29.625". Cabinet will be .75" less in width than the nominal width indicated.</p> <div style="display: flex; justify-content: space-around; align-items: center;"> <div style="text-align: center;">  <p>Width 12" 22 1/2°</p> <p>PLAN ADOE 22 1/2°</p> </div> <div style="text-align: center;">  <p>Width-3/4" 12" 3/4" 45°</p> <p>PLAN ADOE 45°</p> </div> </div>	<p>ADOE 22 1/2° LT or RT 50%</p> <p>ADOE 45° LT or RT 50%</p>
	<p>ANGLE FRONT</p> <p>Angle front is available on cabinet without drawer, 12" wide by 21" or 24" deep. Specify angle left or right. Angle front is 45° with door hinged toward back. Angle door opening is 12.375". Cabinet depth will be .75" less than the nominal depth.</p> <div style="display: flex; align-items: center;">  <p>RIGHT HAND SHOWN</p> </div> <div style="display: flex; align-items: center; margin-top: 10px;">  <p>12" Depth-3/4" 3/4" 45°</p> <p>PLAN</p> </div>	<p style="text-align: right;">PRICE</p> <p>AF LT or RT \$310.43</p>

Modifications

Modifications

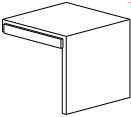
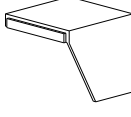
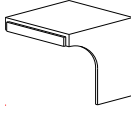

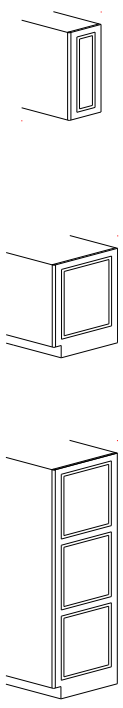
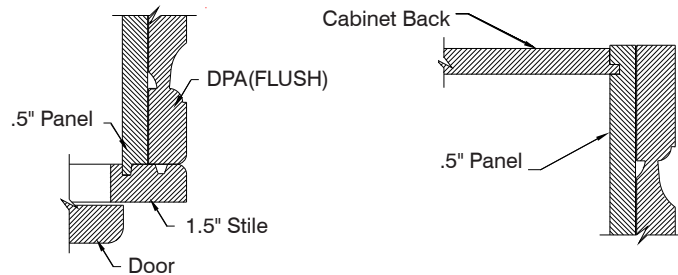
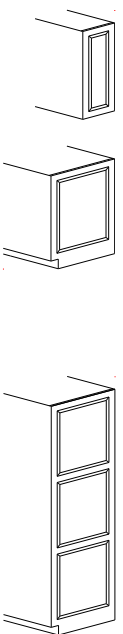
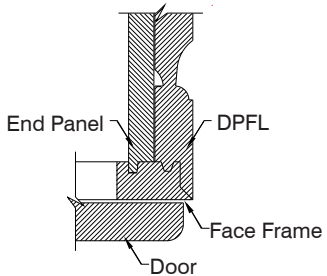

 RIGHT HAND SHOWN	BASE END PANEL ATTACHED																
	Base end panel attached is available on base knee drawer cabinet (BKD). BEP-A is a .75" plywood end panel with 1.5" stile. Indicate attached left or right (24" W x 32" H). Not notched for toe kick. BEP-A does not add width to cabinet. Finished both sides.	<table border="1"> <thead> <tr> <th></th> <th style="text-align: right;">PRICE</th> </tr> </thead> <tbody> <tr> <td>BEP-A LT or RT</td> <td style="text-align: right;">\$326.09</td> </tr> <tr><td> </td><td> </td></tr> <tr><td> </td><td> </td></tr> <tr><td> </td><td> </td></tr> <tr><td> </td><td> </td></tr> <tr><td> </td><td> </td></tr> <tr><td> </td><td> </td></tr> </tbody> </table>		PRICE	BEP-A LT or RT	\$326.09											
	PRICE																
BEP-A LT or RT	\$326.09																
 RIGHT HAND SHOWN	BASE END PANEL DIAGONAL ATTACHED																
	Base end panel diagonal attached is available on base knee drawer cabinet (BKD). BEPD-A is a .75" solid wood end panel. Indicate attached left or right (24" W x 32" H). BEPD-A does not add width to cabinet. Finished both sides.	<table border="1"> <thead> <tr> <th></th> <th style="text-align: right;">PRICE</th> </tr> </thead> <tbody> <tr> <td>BEPD-A LT or RT</td> <td style="text-align: right;">\$347.83</td> </tr> <tr><td> </td><td> </td></tr> <tr><td> </td><td> </td></tr> <tr><td> </td><td> </td></tr> <tr><td> </td><td> </td></tr> <tr><td> </td><td> </td></tr> <tr><td> </td><td> </td></tr> </tbody> </table>		PRICE	BEPD-A LT or RT	\$347.83											
	PRICE																
BEPD-A LT or RT	\$347.83																
 RIGHT HAND SHOWN	BASE END PANEL CURVED ATTACHED																
	Base end panel curved attached is available on base knee drawer cabinet (BKD). BEPC-A is a .75" thick solid wood end panel. Indicate attached left or right (24" W x 32" H). BEPC-A does not add width to cabinet. Finished both sides.	<table border="1"> <thead> <tr> <th></th> <th style="text-align: right;">PRICE</th> </tr> </thead> <tbody> <tr> <td>BEPC-A LT or RT</td> <td style="text-align: right;">\$369.57</td> </tr> <tr><td> </td><td> </td></tr> <tr><td> </td><td> </td></tr> <tr><td> </td><td> </td></tr> <tr><td> </td><td> </td></tr> <tr><td> </td><td> </td></tr> <tr><td> </td><td> </td></tr> </tbody> </table>		PRICE	BEPC-A LT or RT	\$369.57											
	PRICE																
BEPC-A LT or RT	\$369.57																

 <p>Right Hand Shown</p>	<p>DECORATIVE PANEL ATTACHED FLUSH</p> <p>Decorative panels attached are available on cabinet end panels. Indicate attached left or right. Decorative panel style will be the same as specified for cabinet door style with an E5 edge profile.</p> <p>See Accessories for ordering loose decorative panels to be installed on cabinet backs and installed on walls as wainscot.</p> <p>DPA greater than 44" high will have two inserts. DPA greater than 72" high will have three inserts.</p> <p>DPA is not available in Slab or Traditional Mitered door styles.</p> <p>DPA(FLUSH): The decorative panel is flush with the edge of the cabinet end panel.</p> 	<p style="text-align: right;">Up Charge</p> <p>DPA(FLUSH) LT or RT 50%</p>
 <p>RIGHT HAND SHOWN</p>	<p>DECORATIVE PANEL FLUSH</p> <p>Decorative panel flush is available on cabinet end panels. A locking miter joint is used to assemble end panel to the face frame. DPFL does not add width to cabinet. Decorative panel style will be the same as specified for cabinet door style (See exceptions). Indicate left or right.</p>  <p style="text-align: center;">DETAIL</p> <p>DPFL greater than 44" high will have two inserts. DPFL greater than 72" high will have three inserts.</p> <p>DPFL is not available in slab or mitered door styles. CRAWFORD style DP will be substituted when door style is PRESIDENTIAL.</p>	<p style="text-align: right;">Up Charge</p> <p>DPFL LT or RT 75%</p>

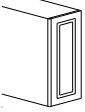
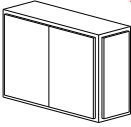
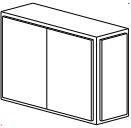
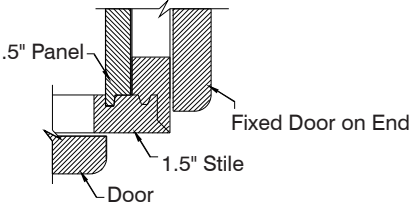
Modifications

Modifications

 <p>Wall Cabinet Right Hand Shown</p>	<p>DOOR ATTACHED</p> <p>Door attached is available on cabinet end panels. Indicate attached left or right. Door attached adds door thickness to the width of the cabinet and will be full height and width of cabinet minus standard door reveals & toe kick. Edge Profile is same as specified for entire set. End panel of cabinet behind door will be flush and finished.</p>	<p style="text-align: right;">Up Charge</p> <p>DRA LT or RT 55%</p>
 <p>RIGHT HAND SHOWN</p>	<p>DOOR ON END</p> <p>When ordering cabinet with door on end, specify left or right end. Standard hinging will always be toward the back unless specified. Toe kick, if applicable, is standard with modification.</p>	<p style="text-align: right;">Up Charge</p> <p>DOE LT or RT 55%</p>
	<p>DOOR ON END - FIXED</p> <p>When ordering cabinet with door on end, specify left or right end. Door will be fixed with an additional 1/2" end panel on the interior. Toe kick, if applicable, is standard with modification.</p>  <p style="text-align: center;">RIGHT HAND SHOWN</p>	<p style="text-align: right;">Up Charge</p> <p>DOEF LT or RT 60%</p>

	<p>CONCEALED SIGNATURE OVERLAY HINGE, SOFT CLOSE</p> <p>CSOSC hinge is a self-closing concealed hinge in a nickel finish with soft close feature. Hinge has three-way adjustment. Maximum door swing is 110°. Hinge allows door to overlay cabinet frame 1.3125". Three hinges are installed on doors greater than 40" high and five hinges are installed on doors greater than 60" high.</p>	<p>CSOSC</p>
	<p>CONCEALED INSET HINGE, SOFT CLOSE</p> <p>CIH is a self-closing concealed hinge in a nickel finish with soft close feature. CIH has three-way adjustment. Maximum door swing is 107°. Three hinges are installed on doors greater than 40" high and five hinges are installed on doors greater than 60" high.</p>	<p>CIHSC</p>
	<p>TDSCA</p> <p>This fixing clip also allows for side to side adjustment, up down adjustment and tilt adjustment. This clip has allows for ultimate adjustment for drawer fronts.</p> 	<p style="text-align: right;">Up Charge</p> <p>TDSCA 1 1/2%</p>
	<p>TANDEM FULL EXTENSION DRAWER SLIDE</p> <p>Drawer slides are a full extension, "TANDEM" slide by BLUM and carry a BLUM Lifetime Warranty. Drawer slides are concealed undermount metal slides with 14 synthetic cylindrical rollers for smooth and quiet running action. Slides feature a 100 pound static load capacity and are designed with a self-closing action and Closure control "BLUMOTION". The Closure Control applies resistance. Two inches from closing, it takes control of the drawer, slowly closes it, and holds it in place. Drawer slides include drawer support brackets. Minimum cabinet depth 12". Specify cabinet depth.</p>	<p>TDSC NC</p>

Modifications

Modifications

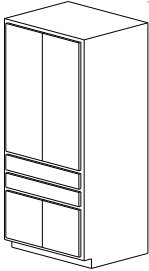
	MAPLE Purebond™ PLYWOOD CONSTRUCTION	
		Up Charge
	Specify WMINT under cabinet modifications in the header to make all cabinets maple Purebond™ plywood INTERIOR.	WMINT 10%
	WALNUT Purebond™ PLYWOOD CONSTRUCTION	
		Up Charge
	Specify WWINT under cabinet modifications in the header to make all cabinets walnut Purebond™ plywood INTERIOR. Available on painted and walnut sets only.	WWINT 10%
	MAPLE MELAMINE CONSTRUCTION	
		Up Charge
	Specify WMINT under cabinet modifications in the header to make all cabinets maple melamine INTERIOR.	MMINT NC
	SPECIAL FACE	
		Up Charge
	Available for any cabinet using standard face frame components, not to exceed maximum and minimum door and drawer opening sizes.	SP FACE 20%
	SPECIAL CABINETS	
	Please seek assistance in pricing unusual cabinets.	



Simplicity
Face Frame

Accessories

Accessories

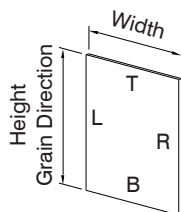
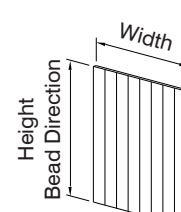
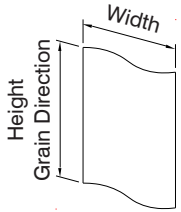
Accessories

		PRICE/FT ²	
	PANELING Paneling is an engineered board with wood veneer, high pressure laminate or melamine. PL is available in the following sizes and woods. .25" thick panel: 48"w x 96"h maximum size, finished one side. .5" thick panel: 48"w x 96"h maximum size, finished both sides. .75" thick panel: 48"w x 96"h maximum size, finished both sides. 96"w x 48"h maximum size, finished one side. 48"w x 120"h maximum size, finished one side. 48"w x 120"h maximum size, finished both sides, available in Alder, Cherry, Maple, QS Sapele, Oak, and K-Alder. Specify panel thickness first, width second, and height third. <u>Grain/pattern will always run with the last dimension indicated.</u> Available Modifications: Finish Both Sides: Available on .5" and .75" by specifying FBS. Edge Band: .5" and .75" panel is available edgebanded all four sides by specifying EB(4)SIDES. Edgeband on paneling will be same color/type as used on cabinet. Order Door Exact for edgeband in same color/type as used on door.	PL(1/4") W x H \$30.43 PL(1/2") W x H \$34.78 PL(3/4") W x H \$34.78 Up Charge FBS 25% EB(4)SIDES 7%	
	BEADED PANELING 	Beaded paneling is available in .5" thick engineered board with wood veneer, beaded one side. Beaded grooves are 1.5" on center. Available in Oak, Maple, Cherry, Alder and K-Alder woods in sizes listed. Specify thickness first, width second, and height third. Beaded grooves and woodgrain will always run with the last dimension indicated. CAUTION: Grooves will vary in color since panel has a engineered board core.	PRICE BEAD PL(.5")24"x32" \$234.78ea BEAD PL(.5")48"x32" \$252.17ea BEAD PL(.5")24"x34.5" \$478.26ea BEAD PL(.5")48"x34.5" \$491.30ea BEAD PL(.5")48"x48" \$673.91ea BEAD PL(.5")48"x96" \$1,339.13ea
		ADHESIVE PANELING Adhesive paneling is wood veneer with adhesive back. Available in sizes up to 24" wide by 96" high. Specify width first, then height. Woodgrain will always run with the last dimension indicated.	PRICE/FT ² APL W x H \$32.78

		PRICE/FT ²
FLOATING SHELF		
<p>Floating shelf is available 18"-96" wide by 8"-15" deep by 2" thick. Floating shelf is constructed of engineered board with wood veneer or high pressure laminate top, bottom, front and ends. Concealed mounting brackets with vertical, horizontal, and inclination adjustments are included.</p> <p>Shelves 18"-36" wide, 2 brackets; 36"-48" wide, 3 brackets; 48"-72" wide, 4 brackets; 72"-96" wide, 5 brackets.</p> <p>NOTE: It is the responsibility of the customer to ensure the wall is of a suitable quality to hold the mounting bracket in place.</p>		FLOAT HS W x L \$226.09
		
END PANEL WITH STILE		
<p>.75" Engineered board with matching exterior material one side. 1.5" or 3" stile is attached to front edge.</p> <p>Special stile width is available up to 6" wide. Specify LT(Left) or RT(Right).</p> <p>WEP(Wall) has a flush bottom. Maximum size is 48" x 72". BEP(Base) maximum size is 48" x 60". VEP(Vanity) maximum size is 48" x 34.5". TEP(Tall) maximum size is 48" x 120".</p> <p>BEP(Base), VEP(Vanity), and TEP(Tall) are standard with flush toe kick. These end panels are available with a toe kick by indicating TK. If end panel needs toe kick space full width of panel, then deduct 4.5" from panel height.</p> <p>Available Modifications:</p> <ul style="list-style-type: none"> * Available with 1.5" or 3" stile attached to front and back edge by indicating peninsula P. * Panel attached to left and right edge of stile by indicating FIP. Minimum width of stile is 2" when indicating FIP. 		PRICE/FT ²
 <p>BEP RT</p> <p>BEP RT P</p> <p>BEP FIP</p>		WEP LT or RT \$78.26 1.5" or 3" x 12" x HT
		BEP LT or RT \$78.26 1.5" or 3" x 24" x 34.5"
		VEP LT or RT \$78.26 1.5" or 3" x 21" x 32"
		TEP LT or RT \$73.91 1.5" or 3" x 12" x 84" 1.5" or 3" x 24" x 84"
		PRICE TK NC P 30% FIP
TALL END PANEL		
		PRICE/FT ²
	.75" plywood with wood veneer both sides and edgeband one long edge. Specify height. Not notched for toe-kick.	TEP 24 x ht \$73.91

Accessories

Accessories

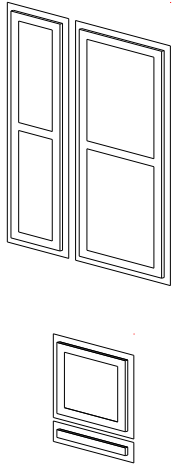
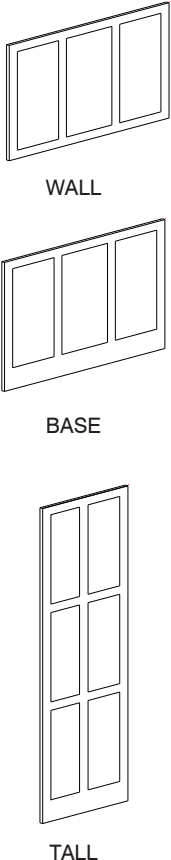
	<p>APPLIANCE DOOR AND DRAWER PANEL</p>	
	<p>ADPL are designed to fit onto appliance fronts. Door and drawer styles will be the same as specified for cabinet door style. A door or drawer front is attached to .25" panel. Specify reveal of the .25" panel on all four edges. If reveal in not indicated, then reveal defaults to 1.8125" on all edges.</p> <p>Specify ADPL-DR overall size by indicating width then height of the .25" backer panel. Specify ADPL-DWR overall size by indicating width then height of .25" backer panel. Manufacturers model number in not sufficient information.</p> <p>WARNING: Many dishwasher machines utilize a condensation drying system. With these dishwashers there is a potential for finish failure if the dishwasher door is opened prior to the steam condensing inside the dishwasher. Crestwood will not warranty finish failures on any door, frame and door or paneling used to cover the face of a dishwasher if steam is allowed to escape out of the dishwasher.</p>	<p style="text-align: right;">PRICE/FT²</p> <p>ADPL-DR W x H \$119.74</p> <p>ADPL-DWR W x H \$119.74</p>
 <p style="text-align: center;">WALL</p> <p style="text-align: center;">BASE</p> <p style="text-align: center;">TALL</p>	<p>DECORATIVE CUSTOM PANEL</p>	
	<p>DCP style will be same style as specified for cabinet door. There are exceptions. Door styles with a mitered frame are not available as a DCP. The bottom frame rail on a DCP base or DCP tall, is 4.5" wider than the standard width rail.</p> <p>Decorative Custom Panel is one piece panel with multiple inserts. Inserts are equally spaced. Specify height and number of inserts.</p> <p>NOTE: Standard with E5 edge profile all (4) edges.</p> <p>A decorative panel corner mold (DPCM) can be used to accent corners. If trim is going to lap decorative panel and corner mold, then the DPCM needs a piece of blocking at the top and/or bottom to fill in behind the trim(DPCB). See molding accessories.</p>	<p style="text-align: right;">PRICE/FT²</p> <p>DCPW W x H INSERT No. \$86.96</p> <p>DCPB W x H INSERT No. \$86.96</p> <p>DCPT W x H INSERT No. \$86.96</p>

<p>DECORATIVE PANEL ARCH</p> <p>Decorative panel arch will be similar in styles as specified for door style. DP ARCH is not available in styles as specified for door styles with decorative top rail, french miter or standard miter frame.</p> <p>DP ARCH is not available with applied moldings. DP ARCH has a decorative profile on bottom edge.</p> <p>* 15" Minimum HT DP ARCH(6)</p> <p>* 18" Minimum HT DP ARCH(9)</p> <p>See technical section for styling.</p>		<p>DP ARCH(6)</p> <table border="1"> <tr> <td>30x15</td> <td>\$1804.35</td> <td>57x15</td> <td>\$2008.70</td> </tr> <tr> <td>33x15</td> <td>\$1826.09</td> <td>60x15</td> <td>\$2034.78</td> </tr> <tr> <td>36x15</td> <td>\$1847.83</td> <td>63x15</td> <td>\$2056.52</td> </tr> <tr> <td>39x15</td> <td>\$1869.57</td> <td>66x15</td> <td>\$2082.61</td> </tr> <tr> <td>42x15</td> <td>\$1891.30</td> <td>69x15</td> <td>\$2100.00</td> </tr> <tr> <td>45x15</td> <td>\$1921.74</td> <td>72x15</td> <td>\$2126.09</td> </tr> <tr> <td>48x15</td> <td>\$1943.48</td> <td></td> <td></td> </tr> <tr> <td>51x15</td> <td>\$1965.22</td> <td></td> <td></td> </tr> <tr> <td>54x15</td> <td>\$1986.96</td> <td></td> <td></td> </tr> </table>	30x15	\$1804.35	57x15	\$2008.70	33x15	\$1826.09	60x15	\$2034.78	36x15	\$1847.83	63x15	\$2056.52	39x15	\$1869.57	66x15	\$2082.61	42x15	\$1891.30	69x15	\$2100.00	45x15	\$1921.74	72x15	\$2126.09	48x15	\$1943.48			51x15	\$1965.22			54x15	\$1986.96		
30x15	\$1804.35	57x15	\$2008.70																																			
33x15	\$1826.09	60x15	\$2034.78																																			
36x15	\$1847.83	63x15	\$2056.52																																			
39x15	\$1869.57	66x15	\$2082.61																																			
42x15	\$1891.30	69x15	\$2100.00																																			
45x15	\$1921.74	72x15	\$2126.09																																			
48x15	\$1943.48																																					
51x15	\$1965.22																																					
54x15	\$1986.96																																					
<p>VALANCES</p> <p>Valances are finished both sides. Specify edge profile on bottom edge (E5, E24 or OGEE). VAL heights are as indicated.</p> <p>CAUTION: Some valance patterns may not look good when reduced in length.</p> <p>VAL B: 4 1/2" height, 6" end</p> <p>VAL C: 4 1/2" height</p> <p>VAL D: 4 1/2" height, 6" end</p> <p>VAL F: 4 1/2" height, 6" end</p> <p>VAL H: 4 1/2" height, 6" end</p> <p>VAL J: 5 1/2" height, 6" end</p> <p>VAL K: 4 3/4" width, 5 1/2" height</p>		<table border="1"> <thead> <tr> <th></th> <th>PRICE</th> </tr> </thead> <tbody> <tr> <td>VAL B,D,F,H</td> <td>\$226.17</td> </tr> <tr> <td>VAL C</td> <td>\$133.04</td> </tr> <tr> <td>VAL J,K</td> <td>\$261.65</td> </tr> <tr> <td>VAL P</td> <td>\$217.39</td> </tr> </tbody> </table>		PRICE	VAL B,D,F,H	\$226.17	VAL C	\$133.04	VAL J,K	\$261.65	VAL P	\$217.39																										
	PRICE																																					
VAL B,D,F,H	\$226.17																																					
VAL C	\$133.04																																					
VAL J,K	\$261.65																																					
VAL P	\$217.39																																					
<p>BM-W DBM DBM-W</p>	<p>BASE MOLD WIDE, DECORATIVE BASE MOLD, & DECORATIVE BASE MOLD W/ VALANCE PROFILE</p> <p>Base Mold Wide, Decorative Base Mold and Decorative Base Mold Wide are available with a valance profile.</p> <p>Specify overall length of molding, cut-out edge profile, width of valance cut-out, and distance to start profile from the right end.</p> <p>Valance profiles L, M & N are not available.</p> <p>VAL B VAL H</p> <p>VAL C VAL J</p> <p>VAL D VAL K</p> <p>VAL F</p> <p>VAL G</p>	<table border="1"> <thead> <tr> <th></th> <th>PRICE</th> </tr> </thead> <tbody> <tr> <td>BM-W-VAL</td> <td>\$291.30</td> </tr> <tr> <td>DBM-VAL</td> <td>\$360.87</td> </tr> <tr> <td>DBM-W-VAL</td> <td>\$360.87</td> </tr> </tbody> </table>		PRICE	BM-W-VAL	\$291.30	DBM-VAL	\$360.87	DBM-W-VAL	\$360.87																												
	PRICE																																					
BM-W-VAL	\$291.30																																					
DBM-VAL	\$360.87																																					
DBM-W-VAL	\$360.87																																					

Accessories

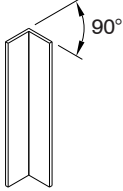
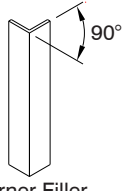
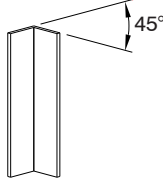
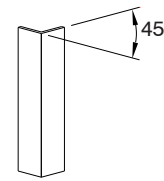
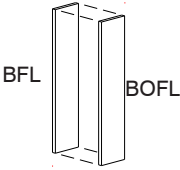
		PRICE/FT ²
	FILLERS WFL(Wall), BFL(Base), VFL(Vanity), TFL(Tall) fillers are .75" thick solid wood or .75" engineered board with matching exterior material one side. Fillers are 3" wide by height specified. If filler for base, vanity or tall needs to allow for toe kick, then deduct 4.5" and specify height. Indicate size by width first and height second. Available Modification: Four 1/4" flutes routed in filler available by specifying FLUTES 1/4. Three 3/8" flutes routed in filler available by specifying FLUTES 3/8. NOTE: Edges will not be banded or finished.	WFL 3" x 30" \$86.96 BFL 3" x 34.5" \$86.96 VFL 3" x 32" \$86.96 TFL 3" x 84" \$86.96 Up Charge FLUTES 1/4 5% FLUTES 3/8 5%
	CORNER FILLERS WCFL(Wall), BCFL(Base), VCFL(Vanity), TCFL(Tall) fillers are .75" thick solid wood. Fillers are 3" x 3" wide by height specified. If filler for base, vanity or tall needs to allow for toe kick, then deduct 4.5" and specify height. Indicate size by width first and height second. Specify inside or outside angle and degree of angle.	WCFL (45° or 90° IA or OA) 3" x 30" \$147.83 BCFL (45° or 90° IA or OA) 3" x 34.5" \$147.83 VCFL (45° or 90° IA or OA) 3" x 32" \$147.83 TCFL (45° or 90° IA or OA) 3" x 84" \$147.83
	 <p>Corner Filler 90° Inside Angle (IA)</p>  <p>Corner Filler 90° Outside Angle (OA)</p>  <p>Corner Filler 45° Inside Angle (IA)</p>  <p>Corner Filler 45° Outside Angle (OA)</p>	
	OVERLAY FILLER WOFL(Wall), BOFL(Base), VOFL(Vanity), TOFL(Tall) fillers are .75" thick solid wood. Overlay filler has same edge profile and finish as drawer front. Overlay filler has edge profile on four edges. Specify nominal size, actual width will be 3/16" less than nominal width indicated and same height as a full height door. Overlay filler includes backing filler piece.	WOFL 3" x 30" \$186.96 BOFL 3" x 34.5" \$186.96 VOFL 3" x 32" \$186.96 TOFL 3" x 84" \$186.96
		

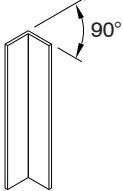
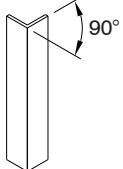
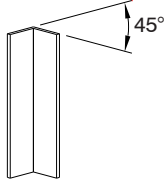
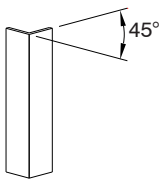
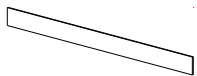
		PRICE/FT ²	
 <p>Overlay Corner Filler 90° Inside Angle (IA)</p>  <p>Overlay Corner Filler 90° Outside Angle (OA)</p>	<p>OVERLAY CORNER FILLERS</p> <p>WOCFL(Wall), BOCFL(Base), VOCFL(Vanity), TOCFL(Tall) fillers are .75" thick solid wood. Overlay filler has same edge profile and finish as drawer front.</p> <p>Specify nominal size, actual width will be 3/16" less than nominal width indicated and same height as a full height door.</p> <p>Specify degree of angle and whether it is an inside or outside angle. Indicate size by width first and height second.</p> <p>Overlay filler includes backing filler piece.</p> <div style="display: flex; justify-content: space-around; align-items: center;"> <div style="text-align: center;">  <p>Overlay Corner Filler 45° Inside Angle (IA)</p> </div> <div style="text-align: center;">  <p>Overlay Corner Filler 45° Outside Angle (OA)</p> </div> </div>	<p>WOCFL (45° or 90° IA or OA) 3" x 30" \$191.30</p> <p>BOCFL (45° or 90° IA or OA) 3" x 34.5" \$173.91</p> <p>VOCFL (45° or 90° IA or OA) 3" x 32" \$191.30</p> <p>TOCFL (45° or 90° IA or OA) 3" x 84" \$260.87</p>	
	<p>TOE KICK STRIP</p> <p>Toe-kick strip is .5" Engineered board with wood veneer one side, 4.5" wide by 96" long. Install over cabinet toe kick after cabinet installation.</p>	<p>TKS \$160.87</p>	

Accessories

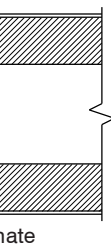

lamine

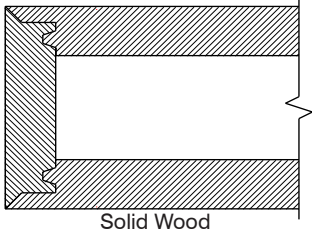
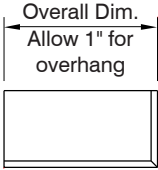
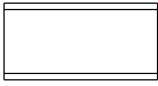
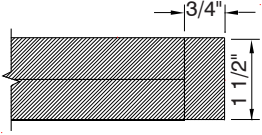
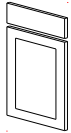
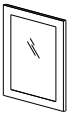

Accessories

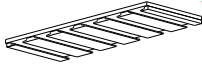
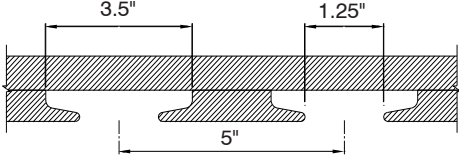
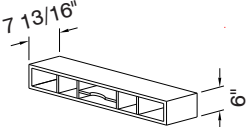
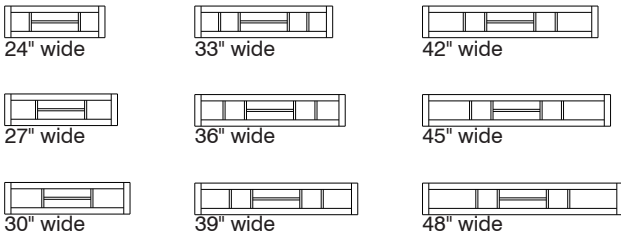

		PRICE/FT ²
	PILASTER	
	<p>Three sided pilaster assembled with .75" engineered board with matching exterior material two sides. If matching solid wood is available, front will be solid wood and assembled with a locking miter. If matching solid wood is not available, matching laminate or veneer will be applied to front. Wall Pilaster has a flush bottom. Base and Tall Pilasters are notched for toe kick. These are available without a toe kick notch by indicating FTK.</p> <p>Pilaster is available four sided by indicating peninsula P. Pilaster is available with Decorative Flush End Panel by indicating DPFL-LT or DPFL-RT.</p> <p>Minimum size is 1.5"w x 12"h - 4"d. Maximum size is 12"w x 120"h - 48"d.</p>  <p style="text-align: center;">Solid Wood</p>	<p>PILASTER-WALL W x H - D \$69.57 PILASTER-BASE W x H - D \$69.57 PILASTER-TALL W x H - D \$69.57</p> <p>FTK List Price \$108.70 P Up Charge 75% DPFL-LT Up Charge 75% DPFL-RT</p>
 <p>Overall Dim. Allow 1" for overhang</p> <p>EDGE MOLD (EM-RT)</p>  <p>EDGE MOLD BACK (EM-BK)</p>	INLAY TOPS	PRICE/FT ²
	<p>Inlay Wood Top (IWT) is 1.5" thick substrate with wood veneer surface and .75" deep decorative solid wood front edge. Maximum length of 96" without a butt joint. Specify depth first and length second. Woodgrain/pattern will always run with the last dimension indicated.</p>  <p>Available Modifications: Edge Mold Left or Right, EM-LT or EM-RT Edge Mold Back, EM-BK</p>	<p>IWT depth x length \$93.13</p> <p>List Price</p> <p>EM-LT or RT \$221.74</p> <p>EM-BK \$354.78</p>
	DOOR AND DRAWER FRONT	PRICE/FT ²
	<p>Specify size of opening for which door will be installed. Order DR EXACT and DWR FRT EXACT to specify exact sizing.</p> <p>Grain/pattern always runs with the last dimension indicated. Specify for hinge direction L or R or no hinging N.</p>	<p>DR W x H \$119.74 DR EXACT W x H \$119.74</p> <p>DWR FRT W(or height) x L \$119.74 DWR FRT EXACT W(or height) x L \$119.74</p>
	DECORATIVE MIRROR FRAME	PRICE
	<p>Decorative Mirror Frames are available in same style as specified for cabinet doors. The DMFR is prep for mirror the same as doors that are prep for glass. DMFR is prep by notching the back of the frame. Notch is .5" wide. Mirror size depends on width of frame. DMFR(W or H) minus Frame(Wx2) plus 3/4" = Mirror(W or H). Mirror is not furnished. DMFR maximum size is 48" x 84". Specify size by indicating width and height.</p>	<p>DMFR W x H \$73.91</p>

		PRICE/FT ²
	<p>STEMWARE RACK</p> <p>Standard depth 11.375" unless specified. Indicate exact length. Number following SWR denotes number of slots. SWR fits most stemware. Specify to finish an exposed end.</p>  <p>SECTION VIEW</p>	<p>SWR4(20"-24") \$252.17</p> <p>SWR5(25"-29") \$252.17</p> <p>SWR6(30"-34") \$252.17</p> <p>SWR7(35"-39") \$252.17</p> <p>SWR8(40"-44") \$252.17</p> <p>SWR9(45"-49") \$252.17</p>
	<p>PIGEONHOLE UNIT</p> <p>Designed to fit under wall cabinets. See below for Partition Plans. Standard width is .625" less than nominal width. Molding is recommended across front and exposed ends. Specify exact width if other than standard width is needed.</p> <p>Partition Plans - Center area will accommodate 8.5" x 11" paper:</p> 	<p>PRICE</p> <p>PHU3006 \$786.96</p> <p>PHU3306 \$895.65</p> <p>PHU3606 \$658.00</p> <p>PHU3906 \$939.13</p> <p>PHU4206 \$960.87</p> <p>PHU4506 \$982.61</p> <p>PHU4806 \$1,000.00</p>

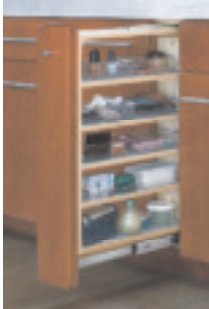
Accessories

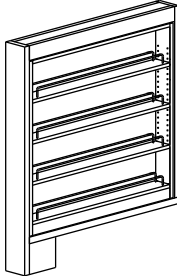
Accessories

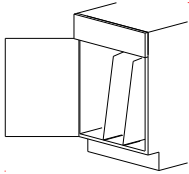

		PRICE	
	PULL-OUT FILLER		
	<p>Pull-Out Filler installs between two cabinets. PFL is 19" deep and is available in 3" or 6" width. PFLV is 32" high and PFLB is 34.5" high.</p> <p>PFL features natural finished wood adjustable shelves with clear polycarbonate rails and non-skid vinyl shelf liners. Clear polycarbonate storage trays are also included to keep smaller items organized. PFLV comes with 4 trays and PFLB comes with 6 trays. Full-extension ball bearing slides are included.</p> <p>PFL includes a filler attached to front and finished all sides. Vanity filler is 3" or 6" wide x 32" high. Base filler is 3" or 6" wide x 34.5" high. Actual size will be .1875" less than nominal width and height indicated.</p> <p>PFL includes a finished flush toe kick base. Indicate NO FTKB to delete the flush toe kick base. Specify if other than standard size filler is required.</p>		<p>PFLV 3 x 32 \$1,319.91</p> <p>PFLV 6 x 32 \$1,319.91</p>
			<p>PFLB 3 x 34.5 \$1,494.52</p> <p>PFLB 6 x 34.5 \$1,494.52</p>
			NO FTKB
 <p>PSRW</p>  <p>PSRB</p> 	PULL-OUT SPICE RACK		
	<p>Pull-Out Spice Rack installs between two cabinets. PSR-Wall Filler is 11.125" deep and PSR-Base Filler is 23" deep. PSR is available in 3" or 6" width by heights indicated.</p> <p>PSR features natural finished wood adjustable shelves with chrome rails and full-extension ball bearing slides.</p> <p>PSR includes a solid filler attached to front and finished all sides. Wall filler is 3" or 6" wide x 30", 36" or 42" high. Base filler is 3" or 6" wide x 34.5" high. Actual size will be .1875" less than nominal width and height indicated.</p> <p>PSR(BFL) includes a finished flush toe kick base. Indicate NO FTKB to delete the flush toe kick base. Specify if other than standard size filler is required.</p>		<p>PSR(WFL) 3 x 30 \$656.35ea.</p> <p>PSR(WFL) 6 x 30</p> <p>PSR(WFL) 3 x 36</p> <p>PSR(WFL) 6 x 36</p>
			<p>PSR(BFL) 3 x 34.5 \$1,024.43ea.</p> <p>PSR(BFL) 6 x 34.5</p>
			NO FTKB

























		PRICE	
 <p>Wood PT</p>  <p>Wood PT with Scoop</p>	<p>PULL-OUT TRAY</p> <p>Pull-Out Trays are constructed as the same drawer box style/wood as entered for entire order. Wood PT is 4" high by standard drawer depth. PT width is 1.5625" less than opening width for Overlay Hinge applications and 3.5625 less than opening width for Inset Hinge applications. Minimum cabinet depth required is 15". PT is adjustable in 1.25" increments.</p> <p>Pull-Tray Options: PT-S, Pull-Tray may be mounted on a secure adjustable shelf.</p> <p>Available Pull-Tray Modifications: NO SS, loose adjustable shelves can be deleted. PT-SCOOP, Pull-Tray is available with a scoop cut in front.</p>	<p>PT \$226.09</p> <p>PT-S \$326.09</p> <p>NO SS -\$65.22</p> <p>PT-SCOOP \$108.70</p>	
	ROLL-OUT CLEANING BASKETS		
	 	PRICE	
		<p>Roll-out cleaning unit comes in chrome. Baskets are portable and include dishwasher safe plastic trays.</p> <p>RCB-S includes with one removable basket and fits in base cabinet with 9" door opening (12" cabinet) unit measures 6 3/8"w x 19 1/2"d x 15 1/2" h.</p> <p>RCB-L includes two removable baskets and one swivel basket and fits in base cabinet with 12" door opening (15" cabinet) unit measures 10 3/4"w x 19 1/2"d x 20"h.</p>	<p>RCB-S \$760.87</p> <p>RCB-L \$1,121.74</p>
		TRAY DIVIDER	
		PRICE	
	<p>Standard tray dividers are 1/2" thick by 16" high. TD in openings less than 17" high will be 1" less than opening height. Indicate number and TD's will be equally spaced in cabinet opening. Two door cabinets with a center stile will need a center partition(CP). See Modifications for center partition. Dividers are same finish as cabinet interior.</p>	<p>TD \$247.83</p>	

Accessories

Simplicity
Face Frame

Accessories

	<p>SWING-UP MIXER SHELF</p> <p>Fits in base full door cabinet. Available in Silver lift with solid wood Natural Maple shelf(SMS-M) or Orion Gray lift with solid wood Natural Walnut shelf(SMS-W).</p> <p>Shelf size is 4 3/4" less than cabinet width by 18" deep.</p> <p>SMS locks in level with countertop and are soft-close and feature built-in shock dampeners and adjustable spring tensions that allow it to glide back into the cabinet gently and quietly. Has load bearing capacity of 33 lbs. Mixer height of 15 3/4" will clear top of cabinet opening. SMS removes standard shelf.</p>		PRICE
		SMS-M	\$826.09
		SMS-W	\$826.09
	<p>SLIDING TOWEL BAR</p> <p>Three extendable silver anodized bars. Available in all base cabinets. Undermounted dimensions 5" x 3", sidemounted dimensions 6" x 1 1/2", STB is 18 1/8" long.</p>		PRICE
		STB LT or RT	\$230.61
	<p>WARDROBE ROD</p> <p>Wardrobe rod is 1 5/16" diameter, matt nickel finish, and available in 5 lengths. WROD comes with rail supports with two pins for 5mm holes. An additional screw hole is furnished for mounting if needed. When estimating, for customer needs, allow 1" to 1 1/4" of rod length for shirt - blouse - slack - skirt. Allow 2" to 2 1/4" of rod length for suits - coat - dresses.</p>		
		WROD 18	\$282.61ea.
		WROD 21	
		WROD 24	
		WROD 30	
		WROD 36	

		PRICE
<p>12" sets: minimum drawer 12" w maximum drawer 15.5" w</p>  <p>THE PORTLAND</p>  <p>THE BOSTON</p>  <p>THE MILAN</p>  <p>THE FRANKFURT</p>  <p>THE SYDNEY</p>	<p>STRAIGHTLINE MOSAIQ DRAWER SETS</p> <p>StraightLine MosaiQ Drawer Sets, available in Birch(B) or Walnut(W), can be combined and arranged to suit the home owner's exact requirements.</p> <p>All sets fit Signature Drawer and Solid Wood Drawer. Depth extension insert is included with each set and can be cut to fit drawer interior depths from 16 11/16" to 20 13/16".</p> <p>6" sets: minimum interior drawer width 6", maximum interior drawer width 9.5"</p>  <p>THE HONOLULU</p>  <p>THE DUBLIN</p>  <p>THE SAN FRANCISCO</p> <p>18" sets: minimum interior drawer width 18-21.5", maximum interior drawer width 24"</p>  <p>THE DENVER</p>  <p>THE MANILA</p>  <p>THE MOSCOW</p>  <p>THE PHILADELPHIA</p> <p>24" sets: minimum interior drawer width 24", maximum interior drawer width 27.25"</p>  <p>THE MADRID</p>  <p>THE BOGOTA</p>  <p>THE MUMBAI</p>  <p>THE DALLAS</p>  <p>LOS ANGELES</p>  <p>THE CAIRO</p> <p>30" sets: minimum interior drawer width 30", maximum interior drawer width 33.25"</p>  <p>THE PARIS</p>  <p>THE SHANGHAI</p>  <p>THE ISTANBUL</p> <p>36" sets: minimum interior drawer width 36", maximum interior drawer width 45.25"</p>  <p>THE NYC</p>  <p>THE LONDON</p>  <p>THE TOKYO</p>	<p>6" SETS:</p> <p>HONOLULU-B \$334.78 HONOLULU-W \$404.35 DUBLIN-B \$382.61 DUBLIN-W \$473.91 SAN FRANCISCO-B \$360.87 SAN FRANCISCO-W \$473.91</p> <p>12" SETS:</p> <p>PORTLAND-B \$469.57 PORTLAND-W \$630.43 BOSTON-B \$321.74 BOSTON-W \$426.09 MILAN-B \$608.70 MILAN-W \$756.52 FRANKFURT-B \$421.74 FRANKFURT-W \$578.26 SYDNEY-B \$526.09 SYDNEY-W \$634.78</p> <p>18" SETS:</p> <p>DENVER-B \$456.52 DENVER-W \$647.83 MANILA-B \$782.61 MANILA-W \$1,073.91 MOSCOW-B \$621.74 MOSCOW-W \$852.17 PHILADELPHIA-B \$443.48 PHILADELPHIA-W \$591.30</p> <p>24" SETS:</p> <p>MADRID-B \$439.13 MADRID-W \$682.61 BOGOTA-B \$791.30 BOGOTA-W \$1,095.65 MUMBAI-B \$652.17 MUMBAI-W \$947.83 DALLAS-B \$652.17 DALLAS-W \$904.35 LOS ANGELES-B \$547.83 LOS ANGELES-W \$843.48 CAIRO-B \$608.70 CAIRO-W</p> <p>30" SETS:</p> <p>PARIS-B \$547.83 PARIS-W \$834.78 SHANGHAI-B \$595.65 SHANGHAI-W \$895.65 ISTANBUL-B \$908.70 ISTANBUL-W \$1,239.13</p> <p>36" SETS:</p> <p>NYC-B \$1,043.48 NYC-W \$1,482.61 LONDON-B \$930.43 LONDON-W \$1,317.39 TOKYO-B \$860.87 TOKYO-W \$1,278.26</p>

Accessories

Accessories

STRAIGHTLINE MOSAIQ DRAWER ACCESSORIES

StraightLine MosaiQ Drawer Accessories, available in Birch(B) or Walnut(W).



Large Wooden Box with grip holes
8 3/8" x 16 11/16" x 4 5/16"



Small Wooden Box with grip holes
8 3/8" x 8 3/8" x 4 5/16"



Metal Divider for Wooden Box
7 5/8" x 3 7/8" x 4"



Plate Rack
13 3/8" x 7 1/16" x 7 1/2"











PRICE





ST LARGE BOX-B	\$260.87
ST LARGE BOX-W	\$578.26
ST SMALL BOX-B	\$147.83
ST SMALL BOX-W	\$360.87
ST METAL DIVIDE	\$147.83
ST PLATE RACK-B	\$373.91
ST PLATE RACK-W	\$652.17

		PRICE
 <p>DRAWER SPICE TRAY</p> <p>Available for cabinets 12" thru 24" wide x 24" deep. Wood spice tray is made of maple, DST(WD-M), or walnut, DST(WD-W), with a natural finish. DST(PL) is made of a high impact, textured polystyrene, with a metallic silver finish.</p> <p>DST will accommodate 1 3/4" x 4 1/4" spice bottles.</p>  		
		DST(WD-M) \$260.87
		DST(WD-W) \$260.87
		DST(PL) \$221.74
 <p>K-CUP DRAWER INSERT</p> <p>Available for 18" and 24" wide x 24" deep cabinets. K-CUP DWR is solid wood construction with a natural finish and holds 30 K-CUPS. 24" wide includes dividers for smaller items on left side.</p> <p>18" WIDE</p>  <p>24" WIDE</p>		
		K-CUP DWR \$326.09
 <p>TIERED K-CUP DRAWER</p> <p>Available in standard top drawer location for 18" wide x 24" deep cabinet. Constructed of solid wood, TK-CUP DWR has two independently sliding tiers in a natural finish. Upper tier holds 40 K-CUPS and lower tier houses 7 storage compartments for sugar, spoons, creamer and more.</p>		
		T K-CUP DWR \$543.48

Accessories

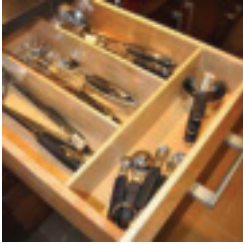
Accessories

 <p>30"</p>  <p>36"</p>	<p>DOUBLE TIER SILVERWARE TRAY(WOOD)</p> <p>Available in standard top drawer location of a 15", 18", 21", 24", 30" or 36" wide x 24" deep cabinet. Constructed of maple solid wood, DTST(WD) has two independently sliding tiers in a natural finish. Foil wrap insert included in 30" and 36" units.</p>  <p>15" 18" 21" 24"</p>	<p style="text-align: right;">PRICE</p> <p>DTST(WD) \$543.48</p>
	<p>CUTLERY DIVIDER (PLASTIC)</p> <p>Available for cabinets 15" thru 24" wide x 24" deep. CD(PL) is made of a high impact, textured polystyrene, with a metallic silver finish. CD(PL) will not fit in cabinet with 2" high drawer.</p> <p>No. of Compartments  15" w cabinet  18" w cabinet  21"-24" w cabinet</p>	<p style="text-align: right;">PRICE</p> <p>CD(PL) \$165.22</p>
 	<p>SILVERWARE TRAY (WOOD) & UTENSIL TRAY(WOOD)</p> <p>ST(WD) is available in drawers for cabinets 15" thru 24" wide. Center compartments are 3" wide. Three center compartments included in 15" thru 18" wide cabinets and five center compartments in 21" thru 24" wide cabinets. Constructed of Maple, ST(WD-M), or Walnut, ST(WD-W), in a natural finish.</p> <p>UT(WD) is available in drawers for cabinet 12" thru 27" wide. UT(WD) center compartments are each 3 1/2" wide. Constructed of Maple, UT(WD-M), or Walnut, UT(WD-W), in a natural finish.</p>	<p style="text-align: right;">PRICE</p> <p>ST(WD-M) \$284.57 ST(WD-W) \$456.52 UT(WD-M) \$217.39 UT(WD-W) \$434.78</p>



		PRICE
	<p>DRAWER DIVIDER VERTICAL OR HORIZONTAL</p> <p>Available for any drawer or pull-out tray. DD's are same material as specified for drawer box and same height as drawer box unless specified. Wood DD's are 3/8" thick. Submit detail plan of DD unless as shown below. Equally spaced unless specified.</p> <p>Examples of DD's (V)Vertical (3)DDV (4)DDH (1)DDH & (3)DDV (H)Horizontal 4" Space</p>	<p>DDV or DDH \$86.96 ea.</p>
	<p>KNIFE BLOCK</p> <p>Knife block is solid wood in a natural finish. KB is available in drawers for cabinets 12", 15", 18" and 21" wide. KB provides up to 19 slots to store knives and a separate compartment for other utensils.</p>	<p>KB \$195.13</p>
 	<p>DOUBLE KNIFE BLOCK</p> <p>Double knife block is available in maple, DKB-M, or walnut, DKB-W, solid wood in a natural finish. DKB is available in drawer openings 20" wide and smaller.</p> <p>Hilt rest keeps knives straight and provides ample finger space for easy removal. One compartment and two tiers that include up to 55 knife slots.</p>	<p>DKB-M \$282.61 DKB-W \$717.39</p>

Accessories

Accessories

Accessories



	FALSE FRONT TRAYS		PRICE
	<p>Stainless steel tray mounts to back of false front and tilts down with self-closing hinges. Fits 18" thru 48" wide cabinets. Cabinets 39" thru 48" wide require two FFT's. Trays are 13", 16", 22" and 28" wide.</p>	FFT	\$217.39
 	DRAWER PEG SYSTEM		PRICE
	<p>Pegboard system allows you to create instant storage for organizing various items. Available in Maple, DPS-M, or Walnut, DPS-W, with matching, press in pegs. Available for cabinets 24" thru 36" wide and 7"h minimum drawer box.</p> <p>Peg Quantities: 24" wide = 9 pegs 25" - 30" wide = 12 pegs 31" - 36" wide = 16 pegs</p> <p>Additional pegs may be ordered in quantities of 4.</p>	DPS-M \$399.13 DPS-W \$833.91 PEGS (4) \$43.48	
	POT/PAN ORGANIZER		PRICE
	<p>Chrome pot/pan organizer for deep drawers is designed to be used with the Drawer Peg System. The design provides complete adjustability for multiple sizes and will accommodate up to five pots and pans. The press-in rack features a trimmable handle rest.</p>	POT ORG	\$110.87
	LID ORGANIZER		PRICE
	<p>Chrome lid organizer for deep drawers is designed to be used with the Drawer Peg System. This press-in rack holds up to six lids.</p>	LID ORG	\$110.87



		PRICE
BUILT-IN IRONING BOARD		
<p>Built-in collapsible ironing board fits in standard height drawer front in cabinet 16 1/2" W x 21" or 24" deep. The BIB is attached to the drawer front and is a strong, all metal assembly. A heat resistant fabric ironing board cover is furnished.</p> <p>NOTE: Not available with inset door application.</p>		BIB \$1490.09
		
BASE SINK WASTE PULL-OUT		
<p>Ideal for under sink base and vanity cabinetry. BSWP includes a 15 liter bin with a white lid for trash, and a 8 liter bin with a green lid for recyclables. Both bins feature built in handles for easy removal and soft-close slides.</p> <p>Unit measurement 8 15/16" w x 16 11/16" d x 14 1/4" h</p>		BSWP \$486.96
		
BASE SINK WASTE & CLEANING PULL-OUT		
<p>Ideal for under sink base and vanity cabinetry. BSWCP includes a 15 liter waste bin with handles and a lid, two 1 liter spray bottles, and additional storage for cleaning supplies, trash bags and more.</p> <p>Unit measurement 8 15/16" w x 16 5/8" d x 14 1/4" h</p>		BSWCP \$460.87
		

Accessories

Simplicity
Face Frame

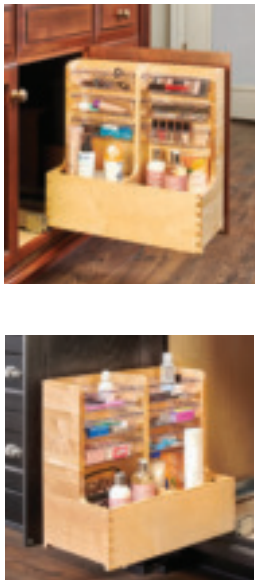
Accessories



		PRICE
	VANITY WASTE CONTAINER Designed for minimum 15" wide vanity cabinet. Door mount maple frame in a natural finish with a single 8 qt. metallic silver waste container with matching lid. Unit measures 10 3/8" w x 7 3/8" d x 12 5/16" h	VWC \$326.09
	VANITY DOOR STORAGE RACK Conveniently store toiletries without compromising design. Designed for 12", 15", and 24" wide vanity cabinets. VDSR features a maple frame in a natural finish and two non-skid vinyl shelves with acrylic accents. Unit Measurements: 12" 8 1/4" w x 3 1/8" d x 15 1/2" h 15" 11 1/4" w x 3 1/8" d x 15 1/2" h 24" 20 1/4" w x 3 1/8" d x 15 1/2" h	VDSR \$413.04
	VANITY SINK ORGANIZER Designed for 24" and 30" wide vanity sink cabinets. Constructed of maple dovetail hardwood in a natural finish. VSO features a unique frame that fits around obtrusive plumbing and glide on full-extension, concealed slides with BLUMOTION. VSO includes non-skid vinyl lining on the lower level and six acrylic bins for the upper level of storage. Unit Measurements: 24" 8 3/4" w x 18 3/4" d x 18 7/8" h 30" 11 11/16" w x 18 3/4" d x 18 7/8" h	VSO \$826.09

	<p>FAUX DECORATIVE INSET HINGE</p> <p>Faux Decorative Barrel Hinge is available for job-site install on inset frame applications. Faux hinge is available in five finishes, Polished Brass (PB), Polished Nickel (PN), Oil Rubbed Bronze (OB), Satin Nickel (SN), and Pewter (PE).</p>	<p style="text-align: right;">PRICE \$34.78(a pair)</p> <p>INS-DPB (Polished Brass) INS-DPN (Polished Nickel) INS-DOB (Oil Rubbed Bronze) INS-DSN (Satin Nickel) INS-DPE (Pewter)</p>
	<p>MAGNETIC CATCH</p> <p>Magnetic catches, white or brown in color, are installed at the top and bottom edge of doors. Magnetic catch has approximately 9 lbs. holding power.</p>	<p style="text-align: right;">PRICE</p> <p>MAG CATCH \$17.39 (White or Brown)</p>

Accessories

Simplicity
Face Frame

Accessories

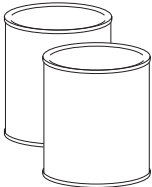
	TWIN BALL CATCH		PRICE
	<p>Twin ball catches, brass finish, are installed at the top and bottom edge of doors. Twin ball catches have screws for adjusting the holding pressure. Twin ball catches are sent loose, for field installation on all doors, prep for glass, that are a minimum of 18 1/2" w by 33 1/2" h or any width by a minimum of 44" in height.</p>	TWIN BALL CATCH	\$34.78
	SHELF SUPPORT		PRICE
	<p>Nickel plated shelf support with 5 mm pin.</p>	SHELF SUPPORTS (20 per bag)	\$13.30(20)
	DOOR BUMPERS		PRICE
	<p>Standard door bumpers are 7/16" diameter, 3/64" thick, clear in color.</p>	DOOR BUMP (Standard-50 per sheet)	\$8.70
	TOUCH-UP KIT		PRICE
	<p>Touch-up Kit will consist of a blendall stick and marker.</p> <p>Order kit by specifying wood and finish color. Kits are not available for special colors. Please order quarts for special stain or paint colors. Not available for Foils or Laminates.</p>	TOUCH-UP KIT	\$65.22
	STAIN AND PAINT FINISHES		PRICE
	<p>Quart size stain or opaque finish. Order by specifying wood and color. Not available for Foils or Laminates</p>	STAIN	\$282.61
	<p>CAUTION: Finish to be applied by professionals only.</p>	OPAQUE	\$191.30

A photograph of a white kitchen cabinet. The upper section has glass-paned doors with decorative muntins. Below, a pull-out shelf is extended, revealing a toaster and a stand mixer. The lower section of the cabinet has solid doors with decorative panels and a pull handle.













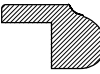





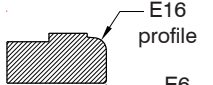







Simplicity
Face Frame

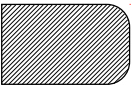



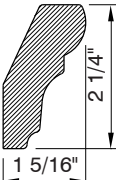
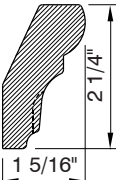
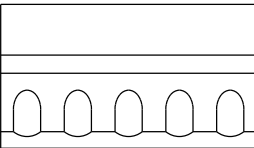



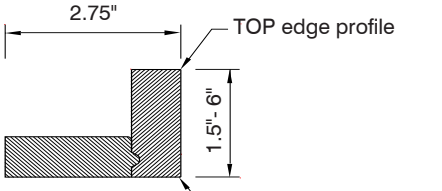

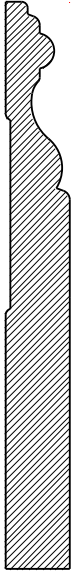
Decorative Accents

Decorative Accents

Simplicity
Face Frame

Decorative

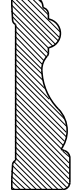
MOLDING			
 CLM (7/16 x 3/4)	<p>Moldings are solid wood with a minimum of 90" in usable material. Select moldings in Oak, Maple, and Cherry woods are available in longer lengths (144) with a minimum of 132" in usable material.</p>  CAP (1 x 1 3/8)  SM (1 x 1 5/8)  VAM (3/4 x 1 1/16)	Colonial Mold (\$75.39) CLM Colonial Mold-Wide(\$110.87) CLM-W Flat Mold (\$75.39) FM Scribe Mold (\$88.70) SCRIBE Decorative Panel	
 CLM-W (7/16 x 1 3/8)		 IAM (1 x 1 1/16)  IM (5/8 x 1) (1/4" Notch)  IM-W (13/16 x 1 1/2) (11/32" Notch)	Corner Mold (\$70.96) DPCM 5/8" Decorative Panel Corner Mold (\$84.26) DPCM 7/8" Decorative Panel Corner Block (\$43.48 sq. ft.) DPCB 3/4" x 12" Accent Mold (\$48.78) AM
 FM (1/4 x 3/4)		 LRM (1 1/2 x 3/4) (1/8" x 5/8" notch) E16 profile E6 profile Designed for use on Face Frame cabinetry, will not work on Frameless cabinets due to door overlays.	Profile Mold (\$57.65) PM Profile Mold-Wide (\$97.57) PM-W Ventura Mold (\$70.96) VM
 SCRIBE (3/8 x 1)		 ECM (3/8 x 3 1/8)	Bead Cap Mold (\$70.96) BCM Cove Mold (\$75.39) CM Base Shoe (\$70.96) BSH
 DPCM (5/8 x 5/8) or (7/8 x 7/8)		 PM (1/4 x 1/2)	Outside Corner Mold (\$84.26) OCM Outside Corner Mold(\$106.43) OCM(45) Cap Mold (\$128.61) CAP Shelf Mold (\$199.57) SM Ventura Apron Mold (\$88.70) VAM Imperial Apron Mold (\$88.70) IAM
 DPCB (3/4 x 3/4) Above is only available in 12" length		 PM-W (1/2 x 1 1/4)	Imperial Mold (\$84.26) IM Imperial Mold-Wide (\$128.61) IM-W Light Rail Mold (\$97.57) LRM
 AM (7/16 x 5/8) (1/4" Notch)		 VM (3/8 x 3/4)	English Country Mold(\$199.57) ECM Light Mold (\$199.57) LM Designer Mold (\$164.09) DM
 LM (1 1/2 x 2)		 DM (1 1/4 x 2)	Solid Wood Mold (price varies by size) SWM Tuscan Mold (\$168.52) TM Tuscan Flute Mold (\$283.83) TFM
 PM-W (1/2 x 1 1/4)		 BCM (3/8 x 3/4)	SWM (Width) edge profile available one side
 VM (3/8 x 3/4)		 CM (3/4 x 3/4)	 TM (3/4 x 2 1/2)  TFM (3/4 x 2 1/2)  Front View with Flutes
 BCM (3/8 x 3/4)		 CM (3/4 x 3/4)	
 CM (3/4 x 3/4)		 BSH (1/2 x 3/4)	
 OCM (7/8 x 7/8)		 OCM 45 (1/2 x 1/2)	 RISER (2.75 x ht) Finished Both Sides TOP edge profile BOTTOM edge profile

MOLDING		
<p>Moldings are solid wood in standard widths with a minimum of 90" in usable material. Select moldings in Oak, Maple, and Cherry woods are available in longer lengths with a minimum of 132" in usable material.</p>		<p>Decorative Base Mold-Imperial DBM-I (\$365.22 ea.) DBM-I132" minimum (\$547.83ea.)</p>
		<p>Decorative Base Mold-Wide DBM-W (\$292.70 ea.) DBM-W 132" minimum (\$434.61 ea.)</p>
		<p>Decorative Base Mold DBM (\$292.70 ea.) DBM 132" minimum (\$434.61 ea.)</p>
		<p>Base Mold-Wide BM-W (\$297.13 ea.) BM-W 132" minimum (\$430.17 ea.)</p>
		<p>Base Mold BM (\$235.04 ea.) BM 132" minimum (\$399.13 ea.)</p>
		<p>Colonial Base CBA (\$217.30 ea.) CBA 132" minimum (\$292.70 ea.)</p>
		<p>Decorative Casing-Imperial DCA-I (\$217.39 ea.) DCA-I 132" minimum (\$326.09 ea.)</p>
		<p>Decorative Casing-Wide DCA-W (\$213.04 ea.) DCA-W 132" minimum (\$317.39 ea.)</p>
		<p>Decorative Casing DCA (\$172.96 ea.) DCA 132" minimum (\$257.22 ea.)</p>
		<p>Colonial Casing CCA (\$159.65 ea.) CCA 132" minimum (\$233.17 ea.)</p>
		
<p>DBM-I (11/16 x 6)</p>		
<p>DBM-W (11/16 x 5 1/4)</p>		
<p>DBM (11/16 x 4 5/8)</p>		
<p>BM-W (11/16 x 4 5/8)</p>		
<p>BM (11/16 x 3 5/8)</p>		
<p>CBA (11/16 x 3 1/4)</p>		
<p>DCA-I (3/4 x 4 1/2)</p>		
<p>DCA-W (3/4 x 3 1/4)</p>		
<p>DCA (3/4 x 2 1/2)</p>		
<p>CCA (3/4 x 2 1/4)</p>		

Decorative

Decorative Accents

Simplicity
Face Frame

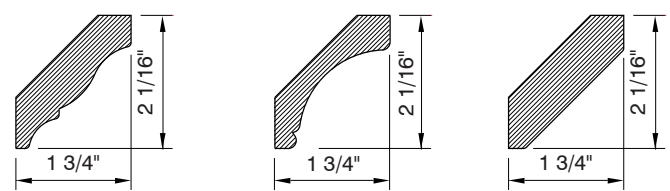
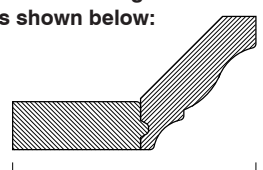
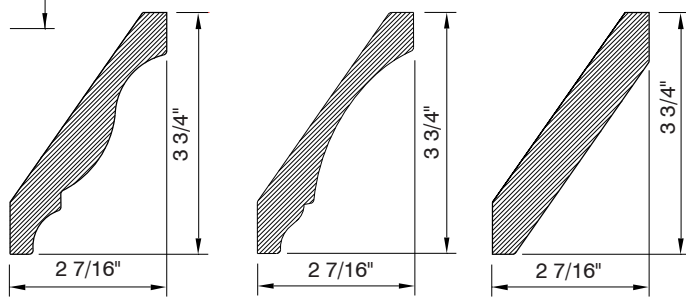
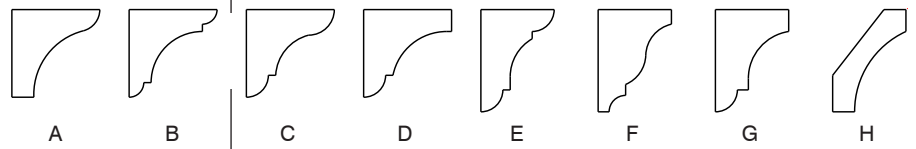
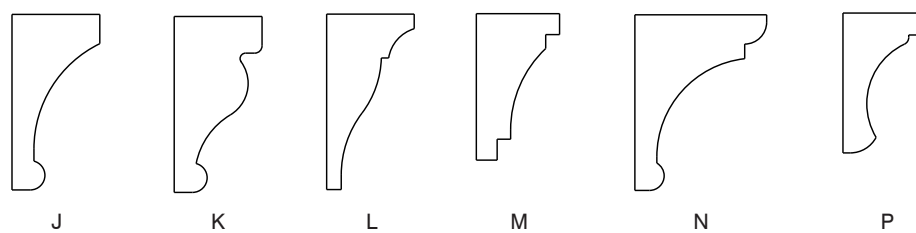
MOLDING		
<p>Moldings are solid wood in standard widths with a minimum of 90" in usable material. Select moldings in Oak, Maple, and Cherry woods are available in longer lengths with a minimum of 132" in usable material.</p>		<p>Crown Mold CRM (\$190.70 ea.) CRM 132" minimum (\$279.39 ea.) CRM-MPF (\$332.61 ea.)</p>
 <p>CRM (3/4 x 2 3/4) DCOVE (3/4 x 2 3/4) SHM (3/4 x 2 3/4)</p>		<p>Crown Mold-Wide CRM-W (\$283.83 ea.) CRM-W 132" minimum (\$425.74ea.) CRM-W-MPF (\$430.17 ea.)</p>
<p>Also available with 2" Flush Mounting Plate as shown below:</p>  <p>CRM-MPF</p>		<p>Decorative Cove Mold DCOVE (\$190.70 ea.) DCOVE 132" minimum (\$283.83ea.) DCOVE-MPF (\$332.61 ea.)</p>
 <p>CRM-W (3/4 x 4 1/2) DCOVE-W (3/4 x 4 1/2) SHM-W (3/4 x 4 1/2)</p>		<p>Decorative Cove Mold-Wide DCOVE-W (\$283.83 ea.) DCOVE-W 132" minimum (\$425.74 ea.) DCOVE-W-MPF (\$430.17 ea.)</p>
		<p>Shaker Mold SHM (\$177.39 ea.) SHM 132" minimum (\$270.52 ea.) SHM-MPF (\$328.17 ea.)</p>
		<p>Shaker Mold-Wide SHM-W (\$274.96 ea.) SHM-W 132" minimum (\$408.00ea.) SHM-W-MPF (\$421.30 ea.)</p>
WOOD SUPPORT BRACKET		
<p>Wood Support Bracket is a solid wood bracket, 1.5" thick by sizes as indicated. WSB is available in fourteen patterns.</p>		PRICE
 <p>A B C D E F G H</p>		<p>WSB A, B, C, D \$213.35 3" x 3" 6" x 6" 9" x 9"</p>
 <p>J K L M N P</p>		<p>WSB E, F, G, \$211.65 5" x 7" 7.5" x 10.5"</p>
		<p>WSB H \$187.09 5" x 7" 7.5" x 10.5"</p>
		<p>WSB J, K, L \$205.43 4.5" x 9" 6" x 12"</p>
		<p>WSB M \$193.30 4.5" x 7.5" 6" x 10"</p>
		<p>WSB N \$240.43 9" x 12"</p>

Decorative

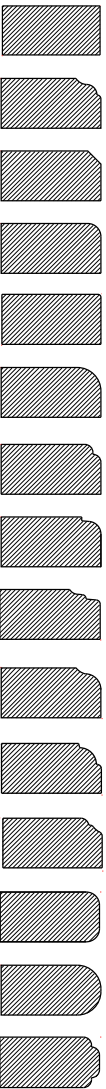
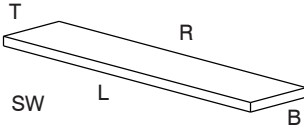
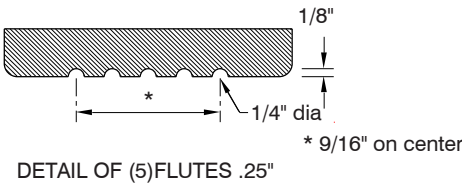
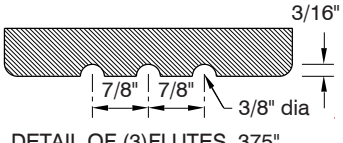
SOLID WOOD		PRICE
 <p>E1 E2 E4 E5 E6 E24 E13 E16 E29 E33 E34 E35 E55 E99 E1313</p> <p>EDGE PROFILES</p>	<p>Solid wood is .75" thick and available up to a maximum size of 16" wide by 90" long. Oak, Maple, and Cherry wood is available in longer lengths with a minimum of 132" in usable material. Indicate width first and length second. Wood grain will always run with the last dimension indicated.</p> <p>Solid wood is finished on one face unless noted to be finish both sides (FBS). Solid wood with E55, E99, and E1313 edge profile will always be FBS.</p> <p>All edges will be square unless indicated with one or more available edge profiles.</p> <p>Specify for edge profile locations: T(Top), B(Bottom), L(Left), R(Right). Example: SW E-13-TLR</p>  <p>Fluting is available by indicating the number, spacing, and length of flutes. Flutes will be centered unless specified. Flutes are .375" or .25".</p>  <p>DETAIL OF (5) FLUTES .25"</p>  <p>DETAIL OF (3) FLUTES .375"</p>	<p>SW W x L \$ 78.26 sq. ft.</p> <p>FBS 25%UC</p> <p>Finish Both Sides</p> <p>E(profile #) L,R,T,B NC</p> <p>Up Charge</p> <p>FLUTE 3/8" 5%</p> <p>FLUTE 1/4" 5%</p>

Decorative Accents

Simplicity
Face Frame

BASE SPINDLES

Standard height is 34.5". Also available in 40.5" high, add 3" to top and bottom with the exception of those with no flat area at the bottom, add 6" to the top.

Available Modifications:
 BSP SPLIT: Splitting yields two equal halves.
 BSP NOTCH: Notching yields a three-quarter piece.

PRICE

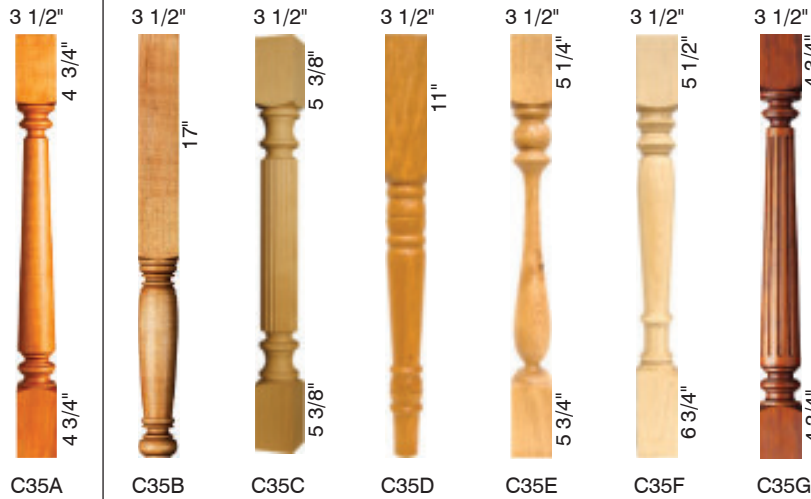

C35A C35B C35C C35D C35E C35F C35G

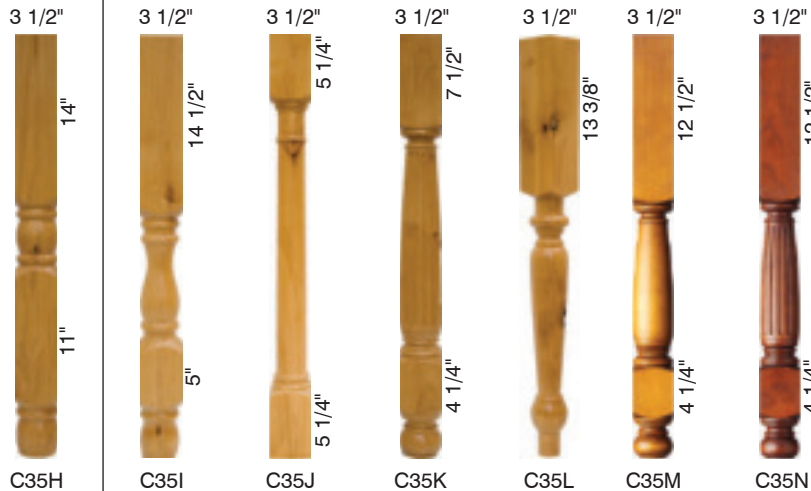

C35H C35I C35J C35K C35L C35M C35N

BSP C35 A-F	\$416.87
BSP C35G	\$403.57
BSP C35H	\$855.91
BSP C35I	\$403.57
BSP C35J	\$403.57
BSP C35K	\$416.87
BSP C35L	\$439.04
BSP C35M	\$403.57
BSP C35N	\$403.57
BSP 40.5	10%UC
BSP SPLIT	\$110.87
BSP NOTCH	\$110.87





Decorative

			PRICE		
<p>C525A</p>	BASE SPINDLES				
	Standard height is 34.5". Also available in 40.5" high, add 3" to top and bottom with the exception of those with no flat area at the bottom, add 6" to the top.		BSP O375A	\$434.52	
	Available Modifications: BSP SPLIT: Splitting yields two equal halves. BSP NOTCH: Notching yields a three-quarter piece.		BSP C375A	\$403.57	
			BSP C375B	\$439.04	
			BSP C375C	\$439.04	
			BSP C375D	\$439.04	
			BSP C375E	\$526.09	
			BSP C375F	\$526.09	
			BSP C45A	\$523.30	
			BSP C45B	\$523.30	
			BSP C45C	\$523.30	
			BSP C475A	\$554.35	
			BSP C5A	\$585.39	
			BSP C5B	\$585.39	
	<p>C375A</p> <p>C375B</p> <p>C375C</p> <p>C375D</p> <p>C375E</p> <p>C375F</p> <p>O375A</p> <p>C45A</p>			BSP C5C	\$585.39
				BSP C5D	\$585.39
				BSP C525A	\$616.43
				BSP 40.5	10% Up Charge
				BSP SPLIT	\$110.87
				BSP NOTCH	\$110.87
<p>C45B</p> <p>C45C</p> <p>C475A</p> <p>C5A</p> <p>C5B</p> <p>C5C</p> <p>C5D</p>					

Decorative Accents

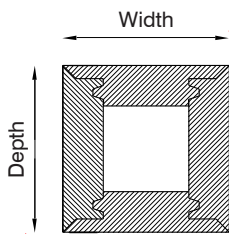
Simplicity
Face Frame

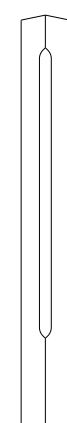
Decorative

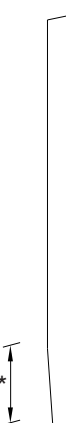
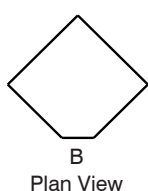
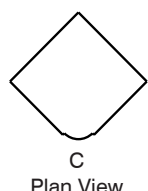
POST		PRICE																																										
<p>Posts are available in 4" to 9" wide or deep by 24" to 96" high in all woods.</p> <p>Posts are constructed of .75" solid wood, lock mitered at all four corners, creating a hollow center.</p> <div style="text-align: center;">  <p>PLAN VIEW</p> </div>		<p>POST wd x ht - dp \$1,020.00</p>																																										
CORNER POST		PRICE																																										
<p>Corner Posts are available in 1.5" to 4" square by lengths indicated in all woods.</p> <p>Wall corner posts WCP are available in 30", 36", and 42" lengths. Base corner posts BCP are available in 32" and 34.5" lengths. Tall Corner post TCP are available in 84", 90", and 96" lengths. WCP decorative area is 2" from top and bottom. BCP and TCP decorative area is 2" from top and 6" from bottom.</p> <div style="display: flex; justify-content: space-around; align-items: flex-start;"> <div style="text-align: center;">  <p>A</p> </div> <div style="text-align: center;">  <p>B</p> </div> <div style="text-align: center;">  <p>C</p> </div> <div style="text-align: center;">  <p>D</p> </div> <div style="text-align: center;">  <p>E</p> </div> <div style="text-align: center;">  <p>B Plan View</p> </div> <div style="text-align: center;">  <p>C Plan View</p> </div> </div> <p>* Tapered height varies on BCP D and E. Specify Taper dimension.</p>		<table border="1"> <tbody> <tr> <td>WCP A 30</td> <td>\$421.74</td> </tr> <tr> <td>WCP A 36</td> <td>\$421.74</td> </tr> <tr> <td>WCP A 42</td> <td>\$421.74</td> </tr> <tr> <td>BCP A 32</td> <td>\$304.35</td> </tr> <tr> <td>BCP A 34 1/2</td> <td>\$304.35</td> </tr> <tr> <td>BCP D and E 32</td> <td>\$470.09</td> </tr> <tr> <td>BCP D and E 34.5</td> <td>\$470.09</td> </tr> <tr> <td>TCP A 84</td> <td>\$953.48</td> </tr> <tr> <td>TCP A 90</td> <td>\$953.48</td> </tr> <tr> <td>TCP A 96</td> <td>\$953.48</td> </tr> <tr> <td>TCP D and E 84</td> <td>\$947.83</td> </tr> <tr> <td>TCP D and E 90</td> <td>\$947.83</td> </tr> <tr> <td>TCP D and E 96</td> <td>\$947.83</td> </tr> <tr> <td>WCP B and C 30</td> <td>\$421.74</td> </tr> <tr> <td>WCP B and C 36</td> <td>\$421.74</td> </tr> <tr> <td>WCP B and C 42</td> <td>\$421.74</td> </tr> <tr> <td>BCP B and C 32</td> <td>\$434.78</td> </tr> <tr> <td>BCP B and C 34.5</td> <td>\$434.78</td> </tr> <tr> <td>TCP B and C 84</td> <td>\$1,108.70</td> </tr> <tr> <td>TCP B and C 90</td> <td>\$1,108.70</td> </tr> <tr> <td>TCP B and C 96</td> <td>\$1,108.70</td> </tr> </tbody> </table>	WCP A 30	\$421.74	WCP A 36	\$421.74	WCP A 42	\$421.74	BCP A 32	\$304.35	BCP A 34 1/2	\$304.35	BCP D and E 32	\$470.09	BCP D and E 34.5	\$470.09	TCP A 84	\$953.48	TCP A 90	\$953.48	TCP A 96	\$953.48	TCP D and E 84	\$947.83	TCP D and E 90	\$947.83	TCP D and E 96	\$947.83	WCP B and C 30	\$421.74	WCP B and C 36	\$421.74	WCP B and C 42	\$421.74	BCP B and C 32	\$434.78	BCP B and C 34.5	\$434.78	TCP B and C 84	\$1,108.70	TCP B and C 90	\$1,108.70	TCP B and C 96	\$1,108.70
WCP A 30	\$421.74																																											
WCP A 36	\$421.74																																											
WCP A 42	\$421.74																																											
BCP A 32	\$304.35																																											
BCP A 34 1/2	\$304.35																																											
BCP D and E 32	\$470.09																																											
BCP D and E 34.5	\$470.09																																											
TCP A 84	\$953.48																																											
TCP A 90	\$953.48																																											
TCP A 96	\$953.48																																											
TCP D and E 84	\$947.83																																											
TCP D and E 90	\$947.83																																											
TCP D and E 96	\$947.83																																											
WCP B and C 30	\$421.74																																											
WCP B and C 36	\$421.74																																											
WCP B and C 42	\$421.74																																											
BCP B and C 32	\$434.78																																											
BCP B and C 34.5	\$434.78																																											
TCP B and C 84	\$1,108.70																																											
TCP B and C 90	\$1,108.70																																											
TCP B and C 96	\$1,108.70																																											

Simplicity
Face Frame

COMPACT 38C/39C & 38N series

Side adjustment



Turn front screw counter-clockwise to increase door overlay, clockwise to decrease. Range = 1/8" (3mm)

Large overlay

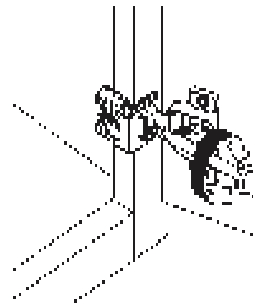

Small overlay

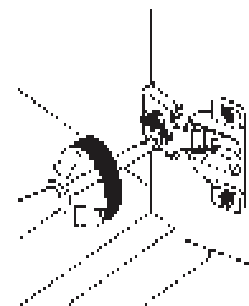

Height adjustment

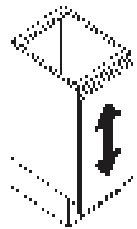

Loosen center screw. Adjust door to position and tighten screw. Range = 1/4" (6mm)

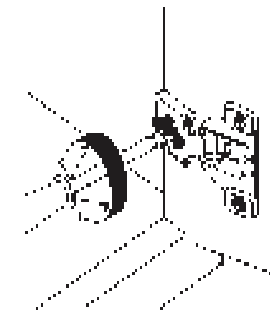
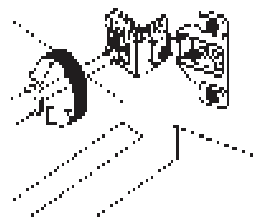

Door removal



Turn back screw counter-clockwise to increase door gap, clockwise to decrease. Range = -1/32" (1mm) + 3/32" (2mm)

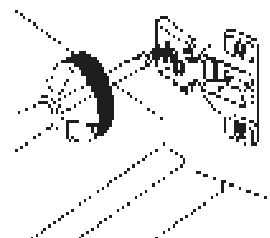
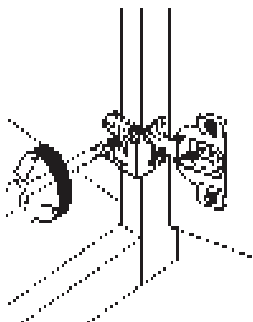

STANDARD CABINET DOOR AND DRAWER FRONT HEIGHTS

Numbers indicate nominal heights in inches

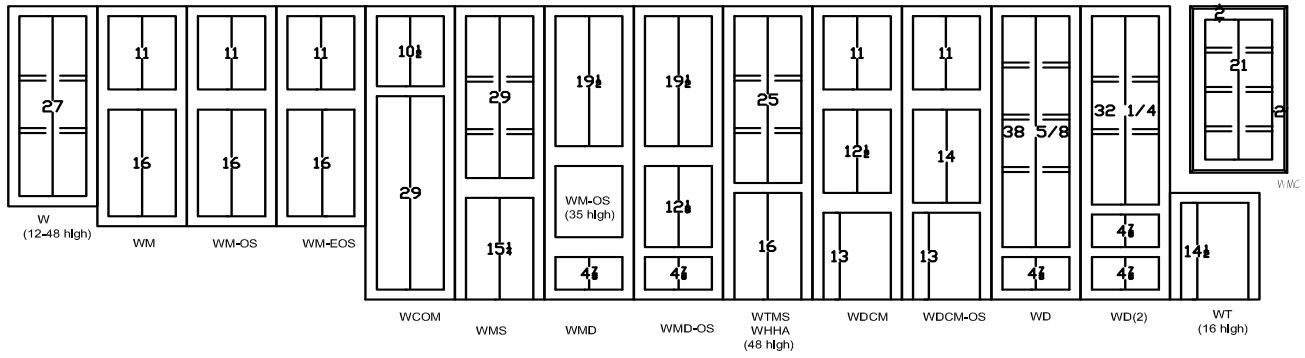

WALL CABINETS

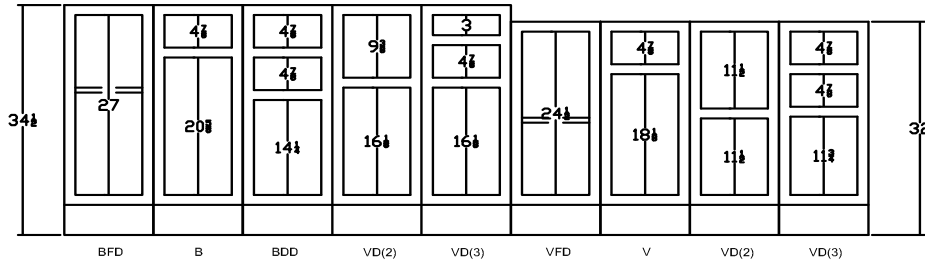

BASE CABINETS

VANITY CABINETS

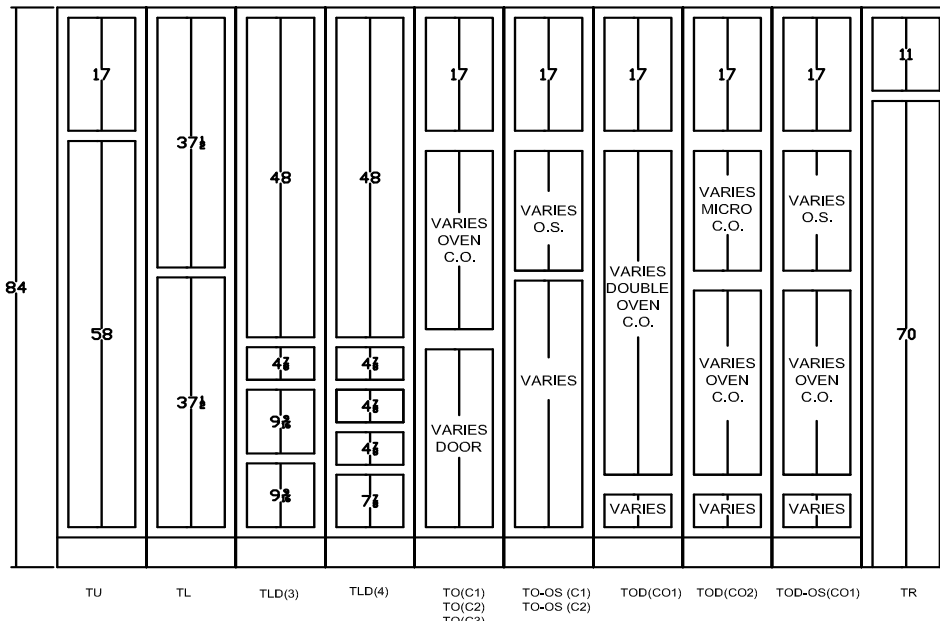

RIGHT TRIANGLES AND 45° CORNERS

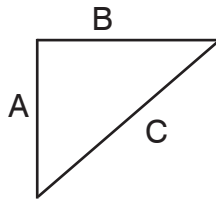

$$A^2 + B^2 = C^2$$

$$3^2 + 3^2 = C^2$$

$$9 + 9 = 18$$

$$C = \sqrt{18} = 4 \frac{1}{4}$$

RIGHT TRIANGLE FORMULA

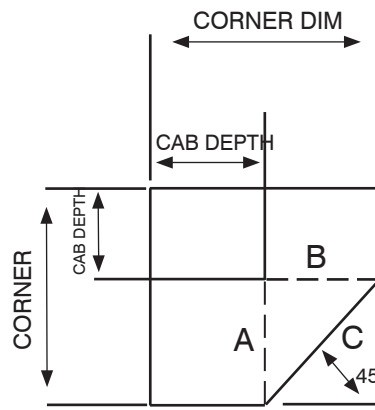

RIGHT TRIANGLE

FORMULA

$$A = C \times .707$$

EXAMPLE

$$\text{CAB DEPTH} = 24''$$

$$C = 34''$$

$$A = 34 \times .707 = 24''$$

$$\text{CORNER DIM} = 48''$$

FORMULA

$$C = A \times 1.414$$

EXAMPLE

$$A = 24''$$

$$C = 24 \times 1.414 = 34''$$

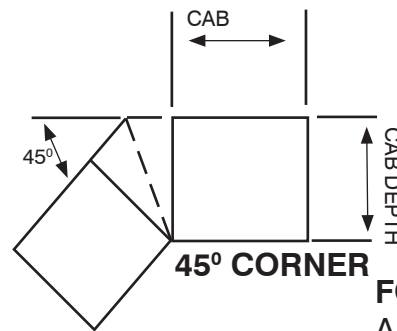
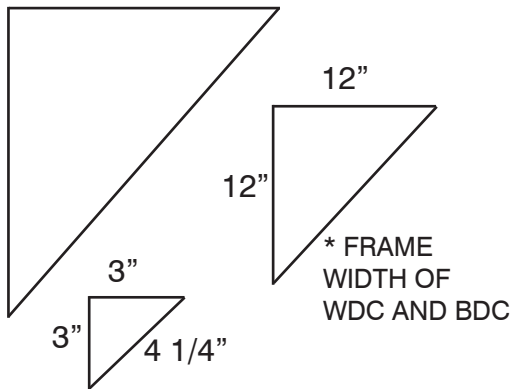

45° CORNER

FORMULA

$$A = \text{CAB DEPTH} \times .414$$

EXAMPLE

$$\text{CAB DEPTH} = 24''$$

CONVERSION TABLES

FRAC	INCH	FRAC	INCH	FRAC	INCH	FRAC	INCH
1/64	0.056	17/64	0.2656	33/64	0.5156	49/64	0.7656
1/32	0.032	9/32	0.2812	17/32	0.5312	25/32	0.7812
3/64	0.0468	19/64	0.2968	35/64	0.5468	51/64	0.7968
1/16	0.0625	5/16	0.3125	9/16	0.5625	13/16	0.8125
5/64	0.0781	21/64	0.3281	37/64	0.5781	53/64	0.8281
3/32	0.0937	11/32	0.3437	19/32	0.5937	27/32	0.8437
7/64	0.1093	23/64	0.3593	39/64	0.6093	55/64	0.8593
1/8	0.125	3/8	0.375	5/8	0.625	7/8	0.875
9/64	0.1406	25/64	0.3906	41/64	0.6406	57/64	0.8906
5/32	0.1562	13/32	0.4062	21/32	0.6562	29/32	0.9062
11/64	0.1718	27/64	0.4218	43/64	0.6718	59/64	0.9218
3/16	0.1875	7/16	0.4375	11/16	0.6875	15/16	0.9375
13/64	0.2031	29/64	0.4531	45/64	0.7031	61/64	0.9531
7/32	0.2187	15/32	0.4687	23/32	0.7187	31/32	0.9687
15/64	0.2343	31/64	0.4843	47/64	0.7343	63/64	0.9843
1/4	0.25	1/2	0.5	3/4	0.75	1	1

Technical

LOCATION GUIDE:

When modifying a door/drawer or adding an accessory to a cabinet, please see the location guide below to show you where to add to the cabinet.

Examples:

PREP Modification - will bring up a prompt asking for a location. If you would like the top opening PREP on a tall cabinet you would use PREP-T from the prompt. If you just wanted the left door you would use PREP-TL.

DTS1 Modification - will bring up a prompt for a drawer location. If you would like it in the top drawer you would choose D1. If it were a split drawer cabinet and you wanted it on the left you would use the prompt of D1L.

PT Modification - will bring up a prompt for a location based on the opening (example O1). Openings always start at the top and move down. So on a base cabinet it would be O2.

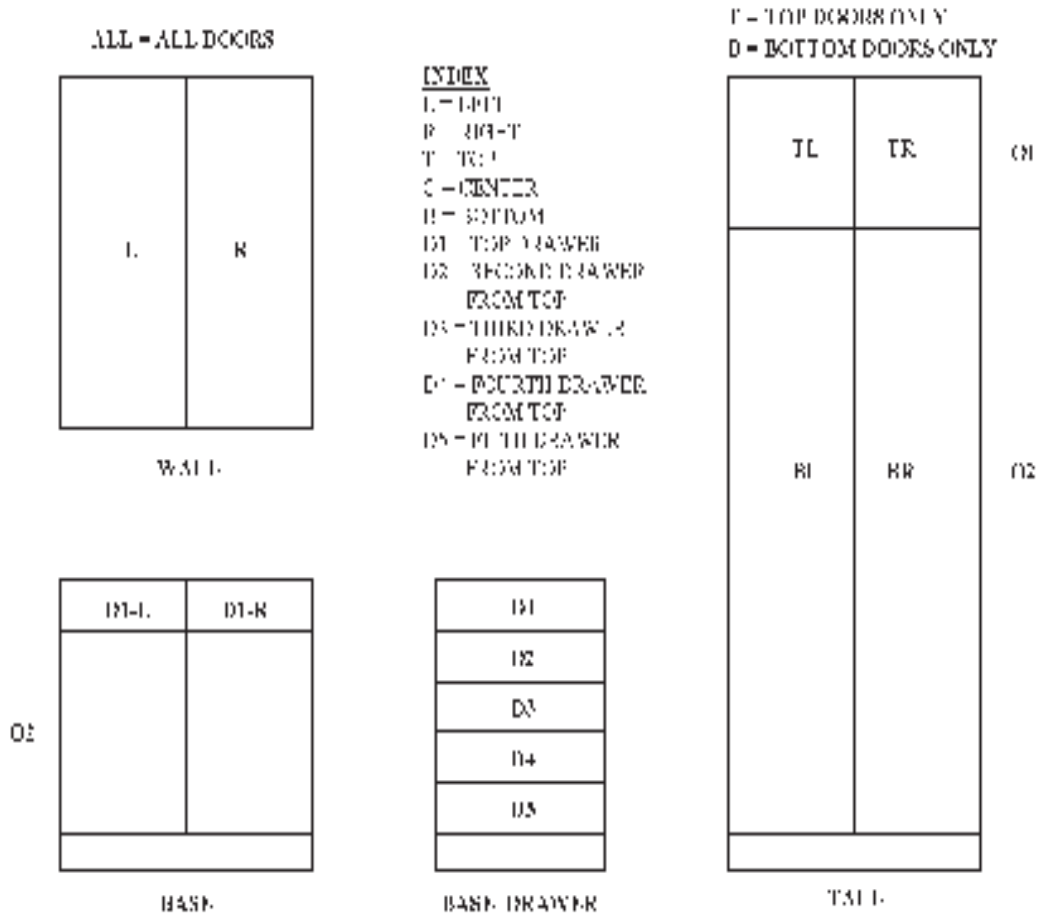

Technical